



ANIXTER

CLARK
An Anixter Company



Contents

Grade 1 Cylindrical Leversets	3-4
Grade 2 Cylindrical Locksets	5-7
Grade 2 Cylindrical Knobsets	8-9
Grade 3 Cylindrical Knobsets	9
Deadlocks	10
Cylinders, Cores, & Housings	11-19
Builders Hardware	20
Exit Devices	23
Storefront Hardware	24
Door Closer	25-27
Padlocks	28
Components	33-38
Finish Code Numbers	39
Certifications	39
Functions	39

GENERAL LOCK FULL LINE CATALOG

1-844-522-5275 | clarksecurity.com

Products. Technology. Services. Delivered Globally.

Contents

Grade 1 Cylindrical Leversets..... 3-4

L100 Series Clutched Levers.....	3
L100 Series Clutched SFIC Levers.....	3
L100 Series Clutched Curved Levers.....	3
LX100 Series Rigid Levers.....	4
LX100 Series Rigid SFIC Levers.....	4
L100 Series Clutched Electrified Levers.....	4

Grade 2 Cylindrical Locksets..... 5-7

L200S Series Clutched Levers.....	5
L200S Series Clutched Dummy Levers.....	6
L200S Series Clutched SFIC Levers.....	6
L200N Series Clutched Levers.....	6
L200N Series Clutched SFIC Levers.....	6
LX200N Series Rigid Levers.....	6
LX200N Series Rigid SFIC Levers.....	6
LX200S Series Rigid Levers.....	7
LX200S Series Rigid SFIC Levers.....	7

Grade 2 Cylindrical Knobsets..... 8-9

K200 Series Cylindrical Knobsets.....	9
K200 Series Cylindrical SFIC Knobsets.....	9

Grade 3 Cylindrical Knobsets..... 9

K300 Series Cylindrical Knobs.....	9
------------------------------------	---

Deadlocks 10

D660 Series Grade 1.....	10
D160 Series Grade 2.....	10

Cylinders, Cores, & Housings 11-19

SFIC Cores 6-Pin.....	11
SFIC Cores 7-Pin.....	11
Key-in-Lever / Knob Cylinders.....	12
Mortise Cylinders.....	14
Mortise Cylinder Parts.....	15
Rim Cylinders.....	16
Dummy Cylinders.....	17
Key Blanks.....	17
Thumb Turns.....	18
Mortise Housings.....	18
Rim Housings.....	18
Cams.....	19
Collars.....	19

Builders Hardware 20

Push, Pull & Kick Plates.....	20
Hole Filler Plates.....	20
Filler Plates.....	21
Scar Plates.....	21
Remodeling Wrap Plates.....	22

Exit Devices 23

ED2300 Series.....	23
ED2300 Series Trims.....	23
ED1000 Series Narrow Stile.....	25

Storefront Hardware..... 24

Pivots.....	25
Exit Devices.....	25
Overhead Concealed - Door Closers.....	25

Door Closer..... 25-27

C9000 Series Surface - Adjustable Size.....	26
C7000 Series Surface - Adjustable Size.....	26
C5000 Series Surface - Adjustable Size.....	26
C3000 Series Surface - Sized.....	26
Door Closers Technical Dimensions.....	27

Padlocks..... 28

Brass Rekeyable Padlocks.....	28
Interchangeable Core Padlocks.....	29
Solid Steel Square Body Padlocks.....	30
Solid Steel Round Body.....	30
Discus Padlocks.....	31
Hidden Shackle Padlocks.....	31
Shrouded Hasp.....	31
Laminated Steel Padlocks.....	32
Padlock Parts.....	32
Padlock Key Blanks.....	32

Components 33-38

Grade 1 Cylindrical Parts & Components.....	33
Grade 2 Cylindrical Parts & Components.....	34
Grade 3 Cylindrical Components.....	35
Deadlock Parts & Components.....	35
Door Closer Components.....	37
ED2300 Series Components.....	38
ED1000 Series Components.....	38

Finish Code Numbers..... 39

Certifications..... 39

Functions..... 39

Grade 1 Cylindrical Leversets

L100 Series Clutched Levers

Part#	Finish	Keyway	Backset	Function	ANSI	CLK#
L110R 605 234	US3		2-3/4"	Passage	F75	cs338534
L110R 613 234	US10B		2-3/4"	Passage	F75	cs338535
L110R 626 234	US26D		2-3/4"	Passage	F75	cs338536
L140R 605 234	US3		2-3/4"	Privacy	F76	cs338537
L140R 613 234	US10B		2-3/4"	Privacy	F76	cs338538
L140R 626 234	US26D		2-3/4"	Privacy	F76	cs338539
L153R 605 C 234	US3	SCHL C	2-3/4"	Entry	F109	cs338524
L153R 613 C 234	US10B	SCHL C	2-3/4"	Entry	F109	cs338528
L153R 626 C 234	US26D	SCHL C	2-3/4"	Entry	F109	cs338529
L170R-360 605 C 234	US3	SCHL C	2-3/4"	Classroom	F84	cs338510
L170R-360 613 C 234	US10B	SCHL C	2-3/4"	Classroom	F84	cs480944
L170R-360 626 C 234	US26D	SCHL C	2-3/4"	Classroom	F84	cs480946
L180R 605 C 234	US3	SCHL C	2-3/4"	Storeroom	F86	cs338540
L180R 613 C 234	US10B	SCHL C	2-3/4"	Storeroom	F86	cs338541
L180R 626 C 234	US26D	SCHL C	2-3/4"	Storeroom	F86	cs338542
L182R 626 C 234	US26D	SCHL C	2-3/4"	Asylum/ Institutional	F87	cs415926
L195R-360 626 C 234	US26D	SCHL C	2-3/4"	Classroom Security	F110	cs480948

L100 Series Clutched SFIC Levers (sold less core)

L153R 605 IC 234	US3	SFIC	2-3/4"	Entry	F109	cs338530
L153R 613 IC 234	US10B	SFIC	2-3/4"	Entry	F109	cs338532
L153R 626 IC 234	US26D	SFIC	2-3/4"	Entry	F109	cs338533
L170R-360 605 IC 234	US3	SFIC	2-3/4"	Classroom	F84	cs495798
L170R-360 613 IC 234	US10B	SFIC	2-3/4"	Classroom	F84	cs480945
L170R-360 626 IC 234	US26D	SFIC	2-3/4"	Classroom	F84	cs480947
L180R 605 IC 234	US3	SFIC	2-3/4"	Storeroom	F86	cs338543
L180R 613 IC 234	US10B	SFIC	2-3/4"	Storeroom	F86	cs338544
L180R 626 IC 234	US26D	SFIC	2-3/4"	Storeroom	F86	cs338545
L195R-360 626 IC 234	US26D	SFIC	2-3/4"	Classroom Security	F110	cs501405

L100 Series Clutched Curved Levers

L110C 626 234	US26D		2-3/4"	Passage	F75	cs440635
L140C 626 234	US26D		2-3/4"	Privacy	F76	cs440636
L153C 626 C 234	US26D	SCHL C	2-3/4"	Entry	F109	cs440637
L170C-360 626 C 234	US26D	SCHL C	2-3/4"	Classroom	F84	cs480943
L180C 626 C 234	US26D	SCHL C	2-3/4"	Storeroom	F86	cs440639

Parts & components found on page 33.

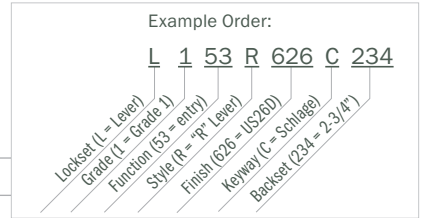

Finishes:



626
U.S. = US26D
Satin Chrome

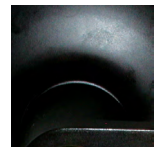

613
U.S. = US10B
Dark Bronze, Oil Rubbed



605
U.S. = US3
Bright Brass



L153R 626 C



L153R 613 C



L153R 605 C



L153C 626 C

Grade 1 Cylindrical Leversets

LX100 Series Rigid Levers

Part#	Finish	Keyway	Backset	Function	ANSI	CLK#
LX140R 626 234	US26D		2-3/4"	Privacy	F76	cs432741
LX153R 613 C 234	US10B	SCHL C	2-3/4"	Entry	F109	cs432742
LX153R 626 C 234	US26D	SCHL C	2-3/4"	Entry	F109	cs432743
LX170R 613 C 234	US10B	SCHL C	2-3/4"	Classroom	F84	cs432747
LX170R 626 C 234	US26D	SCHL C	2-3/4"	Classroom	F84	cs432749
LX180R 626 C 234	US26D	SCHL C	2-3/4"	Storeroom	F86	cs432756
LX180R 613 C 234	US10B	SCHL C	2-3/4"	Storeroom	F86	cs432754

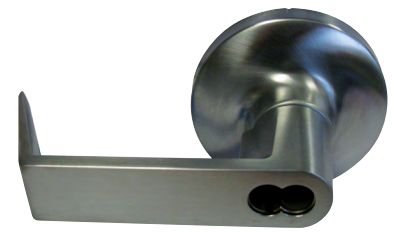

LX180R 626 IC

Features:

- ANSI A156.2 Grade 1, UL Listed 3-hour
- 25 year mechanical warranty, 5 year finish warranty, 1 year warranty on electrified items
- Solid brass cylinder, drilled 6, pinned 6
- Removable Thru-bolts (without using Thru-bolts the lock is not Grade 1 compliant)
- Thru-bolts are fixed on electrified levers
- Case Qty: 6

LX100 Series Rigid SFIC Levers (sold less core)

Part#	Finish	Keyway	Backset	Function	ANSI	CLK#
LX153R 626 IC 234	US26D	SFIC	2-3/4"	Entry	F109	cs432745
LX170R 626 IC 234	US26D	SFIC	2-3/4"	Classroom	F84	cs432752
LX180R 626 IC 234	US26D	SFIC	2-3/4"	Storeroom	F86	cs432757

L100 Series Clutched Electrified Levers

Intermittent Duty (dual voltage)

Part#	Finish	Keyway	Backset	Function	ANSI	CLK#
L180RE FSE 613 IC 234	US10B	SFIC	2-3/4"	Electrically Unlocked		cs418649
L180RE FSE 626 C 234	US26D	SCHL C	2-3/4"	Electrically Unlocked		cs418648
L180RE FSE 626 IC 234	US26D	SFIC	2-3/4"	Electrically Unlocked		cs418651

Continuous Duty

L180RE FSE 12VDC 613 C REX	US10B	SCHL C	2-3/4"	Electrically Unlocked		cs101869
L180RE FSE 12VDC 613 SFIC REX	US10B	SFIC	2-3/4"	Electrically Unlocked		cs101874
L180RE FSE 12VDC 626 C REX	US26D	SCHL C	2-3/4"	Electrically Unlocked		cs101870
L180RE FSE 12VDC 626 SFIC REX	US26D	SFIC	2-3/4"	Electrically Unlocked		cs101875
L180RE FSE 24VDC 613 C REX	US10B	SCHL C	2-3/4"	Electrically Unlocked		cs101871
L180RE FSE 24VDC 613 SFIC REX	US10B	SFIC	2-3/4"	Electrically Unlocked		cs101876
L180RE FSE 24VDC 626 C REX	US26D	SCHL C	2-3/4"	Electrically Unlocked		cs101872
L180RE FSE 24VDC 626 SFIC REX	US26D	SFIC	2-3/4"	Electrically Unlocked		cs101877

L100 Series Clutched Curved Electrified Levers

Intermittent Duty (dual voltage)

L180CE FSE 626 C 234	US26D	SCHL C	2-3/4"	Electrically Unlocked		cs103716
----------------------	-------	--------	--------	-----------------------	--	--------------------------

L180CE FSE 12VDC 626 C REX	US26D	SCHL C	2-3/4"	Electrically Unlocked		cs106132
L180CE FSE 12VDC 613 C REX	US10B	SCHL C	2-3/4"	Electrically Unlocked		cs106131
L180CE FSE 24VDC 626 C REX	US26D	SCHL C	2-3/4"	Electrically Unlocked		cs103715
L180CE FSE 24VDC 613 C REX	US10B	SCHL C	2-3/4"	Electrically Unlocked		cs106140

Parts & components found on page 33.

Electrified Lockset Specifications:	Voltage	Amp Draw	Power Consumption
Continuous Duty Models	12V DC	0.32	3.65W
	24V DC	0.16	3.65W
Intermittent Duty Models (dual voltage)	12V DC	0.6	7.2W
	24V DC	0.3	7.2W

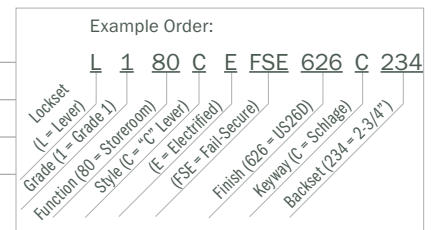

L180RE FSE 12VDC 613 C REX



L180RE FSE 12VDC 626 C REX



L180CE FSE 12VDC 626 C REX

Grade 2 Cylindrical Locksets

L200S Series Clutched Levers

Part#	Finish	Keyway	Backset	Function	ANSI	CLK#
L210S 626 234	US26D		2-3/4"	Passage	F75	cs288614
L210S-70 626 234	US26D		2-3/4"	Passage	F75	cs104086
L210S 605 234	US3		2-3/4"	Passage	F75	cs402356
L210S 605 238 S ANSI KIT	US3		2-3/8"	Passage	F75	cs402401
L210S 605 LL	US3		Less Latch	Passage	F75	cs303053
L210S 613 234	US10B		2-3/4"	Passage	F75	cs390183
L210S 613 LL	US10B		Less Latch	Passage	F75	cs303054
L210S 626 238	US26D		2-3/8"	Passage	F75	cs390186
L210S 626 LL	US26D		Less Latch	Passage	F75	cs303056
L240S 605 234 S ANSI	US3		2-3/4"	Privacy	F76	cs288619
L240S 605 238 S ANSI KIT	US3		2-3/8"	Privacy	F76	cs402402
L240S 605 LL	US3		Less Latch	Privacy	F76	cs303083
L240S 613 234	US10B		2-3/4"	Privacy	F76	cs390187
L240S 613 238 S ANSI KIT	US10B		2-3/8"	Privacy	F76	cs390188
L240S 613 LL	US10B		Less Latch	Privacy	F76	cs303086
L240S 626 234	US26D		2-3/4"	Privacy	F76	cs288621
L240S-70 626 234	US26D		2-3/4"	Privacy	F76	cs104087
L240S 626 238	US26D		2-3/8"	Privacy	F76	cs390190
L240S 626 LL	US26D		Less Latch	Privacy	F76	cs303089
L253S 605 C 234	US3	SCHL C	2-3/4"	Entry	F109	cs288602
L253S 605 C 238	US3	SCHL C	2-3/8"	Entry	F109	cs402405
L253S 605 C LL	US3	SCHL C	Less Latch	Entry	F109	cs302996
L253S 613 C 234	US10B	SCHL C	2-3/4"	Entry	F109	cs288603
L253S 613 C LL	US10B	SCHL C	Less Latch	Entry	F109	cs302999
L253S 626 C 234	US26D	SCHL C	2-3/4"	Entry	F109	cs288604
L253S-70 626 C 234	US26D	SCHL C	2-3/4"	Entry	F109	cs104088
L253S 626 C 234	US26D	SCHL C	2-3/4"	Entry	F109	cs390193
L253S 626 C 238	US26D	SCHL C	2-3/8"	Entry	F109	cs390194
L253S 626 C LL	US26D	SCHL C	Less Latch	Entry	F109	cs303002
L270S-360 605 C 234	US3	SCHL C	2-3/4"	Classroom	F84	cs480962
L270S-360 613 C 234	US10B	SCHL C	2-3/4"	Classroom	F84	cs480964
L270S-360 626 C 234	US26D	SCHL C	2-3/4"	Classroom	F84	cs480965
L270S-70-360 626 C 234	US26D	SCHL C	2-3/4"	Classroom	F84	cs104090
L270S-360 626 C 238 S ANSI KIT	US26D	SCHL C	2-3/8"	Classroom	F84	cs486172
L270S-360 626 C LL	US26D	SCHL C	Less Latch	Classroom	F84	cs480966
L280S 605 C 234	US3	SCHL C	2-3/4"	Storeroom	F86	cs402359
L280S 605 C 238 S ANSI KIT	US3	SCHL C	2-3/8"	Storeroom	F86	cs402408
L280S 605 C LL	US3	SCHL C	Less Latch	Storeroom	F86	cs303188
L280S 613 C 234	US10B	SCHL C	2-3/4"	Storeroom	F86	cs390195
L280S 613 C 238 S ANSI KIT	US10B	SCHL C	2-3/8"	Storeroom	F86	cs390196
L280S 613 C LL	US10B	SCHL C	Less Latch	Storeroom	F86	cs303189
L280S 626 C 234	US26D	SCHL C	2-3/4"	Storeroom	F86	cs288628
L280S-70 626 C 234	US26D	SCHL C	2-3/4"	Storeroom	F86	cs104096
L280S 626 C 238	US26D	SCHL C	2-3/8"	Storeroom	F86	cs390198
L280S 626 C LL	US26D	SCHL C	Less Latch	Storeroom	F86	cs303191

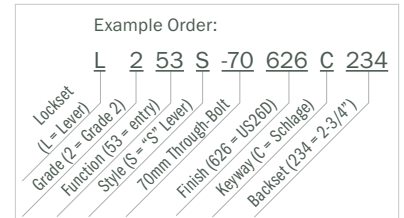

Finishes:



626
U.S. = US26D
Satin Chrome

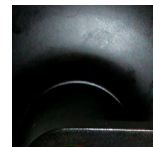

613
U.S. = US10B
Dark Bronze, Oil Rubbed



605
U.S. = US3
Bright Brass

Features:

- ANSI A156.2 Grade 2, UL Listed 3-hour
- 25 year mechanical warranty, 5 year finish warranty
- Solid brass cylinder, drilled 6, pinned 6
- Removable Thru-bolts (without using Thru-bolts the lock is not Grade 2 compliant)
- Case Qty: 6

L200S Series available with **70mm** through-bolts to match templating of additional brands.

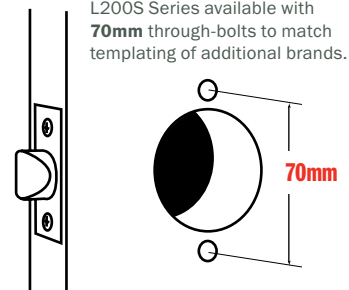

Grade 2 Cylindrical Locksets

L200S Series Clutched Dummy Levers

Part#	Finish	Keyway	Backset	Function	ANSI	CLK#
L2170S 605	US3			Dummy		cs288595
L2170S 613	US10B			Dummy		cs288596
L2170S 626	US26D			Dummy		cs288597



L2170S 626

L200S Series Clutched SFIC Levers (sold less core)

Part#	Finish	Keyway	Backset	Function	ANSI	CLK#
L253S 605 IC 234	US3	SFIC	2-3/4"	Entry	F109	cs343671
L253S 613 IC 234	US10B	SFIC	2-3/4"	Entry	F109	cs246338
L253S 626 IC 234	US26D	SFIC	2-3/4"	Entry	F109	cs246339
L253S-70 626 IC 234	US26D	SFIC	2-3/4"	Entry	F109	cs104089
L270S-360 605 IC 234	US3	SFIC	2-3/4"	Classroom	F84	cs480963
L270S-360 613 IC 234	US10B	SFIC	2-3/4"	Classroom	F84	cs495797
L270S-360 626 IC 234	US26D	SFIC	2-3/4"	Classroom	F84	cs480967
L270S-70-360 626 IC 234	US26D	SFIC	2-3/4"	Classroom	F84	cs104095
L280S 605 IC 234	US3	SFIC	2-3/4"	Storeroom	F86	cs343674
L280S 613 IC 234	US10B	SFIC	2-3/4"	Storeroom	F86	cs246343
L280S 626 IC 234	US26D	SFIC	2-3/4"	Storeroom	F86	cs246344
L280S-70 626 IC 234	US26D	SFIC	2-3/4"	Storeroom	F86	cs104097

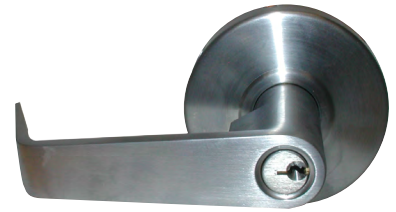

L253S 626 C



L253S 613 C

L200N Series Clutched Levers

Part#	Finish	Keyway	Backset	Function	ANSI	CLK#
L210N 626 234	US26D		2-3/4"	Passage	F75	cs101878
L240N 626 234	US26D		2-3/4"	Privacy	F76	cs101880
L253N 626 C 234	US26D	SCHL C	2-3/4"	Entry	F109	cs101882
L270N-360 626 C 234	US26D	SCHL C	2-3/4"	Classroom	F84	cs101885
L280N 626 C 234	US26D	SCHL C	2-3/4"	Storeroom	F86	cs101887
L2170N 626	US26D			Dummy		cs101879



L253S 605 C

L200N Series Clutched SFIC Levers (sold less core)

Part#	Finish	Keyway	Backset	Function	ANSI	CLK#
L253N 626 IC 234	US26D	SFIC	2-3/4"	Entry	F109	cs101884
L270N-360 626 IC 234	US26D	SFIC	2-3/4"	Classroom	F84	cs101886
L280N 626 IC 234	US26D	SFIC	2-3/4"	Storeroom	F86	cs101888



L270N 626

LX200N Series Rigid Levers

Part#	Finish	Keyway	Backset	Function	ANSI	CLK#
LX253N 626 C 234	US26D	SCHL C	2-3/4"	Entry	F109	cs101890
LX270N-360 626 C 234	US26D	SCHL C	2-3/4"	Classroom	F84	cs101892
LX280N 626 C 234	US26D	SCHL C	2-3/4"	Storeroom	F86	cs101893

LX200N Series Rigid SFIC Levers (sold less core)

Part#	Finish	Keyway	Backset	Function	ANSI	CLK#
LX253N 626 IC 234	US26D	SFIC	2-3/4"	Entry	F109	cs101891
LX280N 626 IC 234	US26D	SFIC	2-3/4"	Storeroom	F86	cs101894

Parts & components
found on page 34

Grade 2 Cylindrical Locksets

LX200S Series Rigid Levers

Part#	Finish	Keyway	Backset	Function	ANSI	CLK#
LX253S 626 C 234	US26D	SCHL C	2-3/4"	Entry	F109	cs288607
LX253S 605 C 234 S ANSI KIT	US3	SCHL C	2-3/4"	Entry	F109	cs402360
LX253S 605 C 238 S ANSI KIT	US3	SCHL C	2-3/8"	Entry	F109	cs402409
LX253S 605 C LL	US3	SCHL C	Less Latch	Entry	F109	cs303004
LX253S 613 C 234 S ANSI KIT	US10B	SCHL C	2-3/4"	Entry	F109	cs390202
LX253S 613 C 238 S ANSI KIT	US10B	SCHL C	2-3/8"	Entry	F109	cs390203
LX253S 613 C LL	US10B	SCHL C	Less Latch	Entry	F109	cs303007
LX253S 626 C 238 S ANSI KIT	US26D	SCHL C	2-3/8"	Entry	F109	cs390206
LX253S 626 C LL	US26D	SCHL C	Less Latch	Entry	F109	cs303016
LX270S 613 C LL	US10B	SCHL C	Less Latch	Classroom	F84	cs302969
LX270S 626 C 234	US26D	SCHL C	2-3/4"	Classroom	F84	cs288594
LX270S 626 C LL	US26D	SCHL C	Less Latch	Classroom	F84	cs302972
LX270S-360 613 C 234 S ANSI	US10B	SCHL C	2-3/4"	Classroom	F84	cs102510
LX270S-360 613 C 238 S ANSI	US10B	SCHL C	2-3/8"	Classroom	F84	cs102513
LX270S-360 613 C LL ANSI	US10B	SCHL C	Less Latch	Classroom	F84	cs102520
LX270S-360 626 C 234 S ANSI	US26D	SCHL C	2-3/4"	Classroom	F84	cs102530
LX270S-360 626 C 238 S ANSI	US26D	SCHL C	Less Latch	Classroom	F84	cs102539
LX270S-360 626 C LL ANSI	US26D	SCHL C	Less Latch	Classroom	F84	cs102540
LX280S 605 C 234	US3	SCHL C	2-3/4"	Storeroom	F86	cs288629
LX280S 613 C 234 S ANSI KIT	US10B	SCHL C	2-3/4"	Storeroom	F86	cs390211
LX280S 613 C 238 S ANSI KIT	US10B	SCHL C	2-3/8"	Storeroom	F86	cs390212
LX280S 613 C LL	US10B	SCHL C	Less Latch	Storeroom	F86	cs303193
LX280S 626 C 234	US26D	SCHL C	2-3/4"	Storeroom	F86	cs288631
LX280S 626 C 238 S ANSI KIT	US26D	SCHL C	2-3/8"	Storeroom	F86	cs390214
LX280S 626 C LL	US26D	SCHL C	Less Latch	Storeroom	F86	cs303194

LX200S Series Rigid SFIC Levers (sold less core)

LX253S 613 IC 234	US10B	SFIC	2-3/4"	Entry	F109	cs243397
LX253S 626 IC 234	US26D	SFIC	2-3/4"	Entry	F109	cs243399
LX280S 613 IC 234	US10B	SFIC	2-3/4"	Storeroom	F86	cs246345
LX280S 626 IC 234	US26D	SFIC	2-3/4"	Storeroom	F86	cs246347

Parts & components found on page 34.

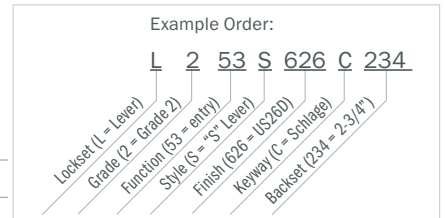

Finishes:



626
U.S. = US26D
Satin Chrome

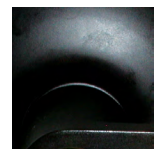

613
U.S. = US10B
Dark Bronze, Oil Rubbed



605
U.S. = US3
Bright Brass

Grade 2 Cylindrical Knobsets

K200 Series Cylindrical Knobsets

Part#	Finish	Keyway	Backset	Function	ANSI	CLK#
K210B 630 234	US32D		2-3/4"	Passage	F75	cs288286
K210B 605 234	US3		2-3/4"	Passage	F75	cs402341
K210B 605 238 S ANSI KIT	US3		2-3/8"	Passage	F75	cs402369
K210B 605 LL	US3		Less Latch	Passage	F75	cs303018
K210B 613 234 S ANSI KIT	US10B		2-3/4"	Passage	F75	cs390215
K210B 613 238 S ANSI KIT	US10B		2-3/8"	Passage	F75	cs390216
K210B 613 LL	US10B		Less Latch	Passage	F75	cs303019
K210B 630 238	US32D		2-3/8"	Passage	F75	cs390218
K210B 630 LL	US32D		Less Latch	Passage	F75	cs303029
K210P 605 234	US3		2-3/4"	Passage	F75	cs288287
K210P 605 238 S ANSI KIT	US3		2-3/8"	Passage	F75	cs477998
K210P 605 LL	US3		Less Latch	Passage	F75	cs303030
K240B 605 234 S ANSI KIT	US3		2-3/4"	Privacy	F76	cs402343
K240B 605 238 S ANSI KIT	US3		2-3/8"	Privacy	F76	cs402371
K240B 605 LL	US3		Less Latch	Privacy	F76	cs303057
K240B 613 LL	US10B		Less Latch	Privacy	F76	cs303059
K240B 630 234	US32D		2-3/4"	Privacy	F76	cs390221
K240B 630 238 S ANSI KIT	US32D		2-3/8"	Privacy	F76	cs390222
K240B 630 LL	US32D		Less Latch	Privacy	F76	cs303063
K240P 605 238 S ANSI KIT	US3		2-3/8"	Privacy	F76	cs478001
K240P 605 LL	US3		Less Latch	Privacy	F76	cs303065
K253B 605 C 234	US3	SCHL C	2-3/4"	Entry	F109	cs402344
K253B 605 C 238	US3	SCHL C	2-3/8"	Entry	F109	cs402375
K253B 605 C LL	US3	SCHL C	Less Latch	Entry	F109	cs302982
K253B 613 C 234	US10B	SCHL C	2-3/4"	Entry	F109	cs390223
K253B 613 C 238	US10B	SCHL C	2-3/8"	Entry	F109	cs390224
K253B 613 C LL	US10B	SCHL C	Less Latch	Entry	F109	cs302987
K253B 630 C 234	US32D	SCHL C	2-3/4"	Entry	F109	cs288278
K253B 630 C 234	US32D	SCHL C	2-3/4"	Entry	F109	cs390225
K253B 630 C 238	US32D	SCHL C	2-3/8"	Entry	F109	cs390226
K253B 630 C LL	US32D	SCHL C	Less Latch	Entry	F109	cs302988
K270B 613 C 238 S ANSI KIT	US10B	SCHL C	2-3/8"	Classroom	F84	cs390228
K270B 613 C LL	US10B	SCHL C	Less Latch	Classroom	F84	cs302957
K270B 630 C 234	US32D	SCHL C	2-3/4"	Classroom	F84	cs390229
K270B 630 C 238	US32D	SCHL C	2-3/8"	Classroom	F84	cs390230
K270B 630 C LL	US32D	SCHL C	Less Latch	Classroom	F84	cs302959
K280B 613 C 234	US10B	SCHL C	2-3/4"	Storeroom	F86	cs390231
K280B 613 C 238 S ANSI KIT	US10B	SCHL C	2-3/8"	Storeroom	F86	cs390232
K280B 613 C LL	US10B	SCHL C	Less Latch	Storeroom	F86	cs303176
K280B 630 C 234	US32D	SCHL C	2-3/4"	Storeroom	F86	cs288303
K280B 630 C 238	US32D	SCHL C	2-3/8"	Storeroom	F86	cs390234
K280B 630 C LL	US32D	SCHL C	Less Latch	Storeroom	F86	cs303177

Parts & components found on page 34.

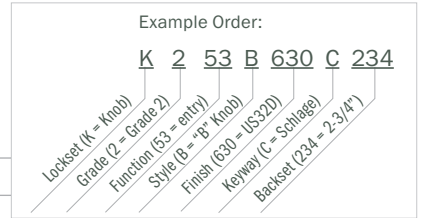

Finishes:



630
U.S. = US32D
Satin Stainless Steel

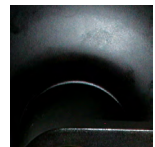

613
U.S. = US10B
Dark Bronze, Oil Rubbed



605
U.S. = US3
Bright Brass



K253B 630 C

K253B 613 C



K253B 605 C

K253P 605 C

Features:

- ANSI A156.2 Grade 2, UL Listed 3-hour
- 25 year mechanical warranty, 5 year finish warranty
- Solid brass cylinder, drilled 6, pinned 6
- KA4 is drilled 6, pinned 5

Grade 2 Cylindrical Knobsets

K200 Series Cylindrical Knobsets (cont.)

Part#	Finish	Keyway	Backset	Function	ANSI	CLK#
K253P 605 C 234	US3	SCHL C	2-3/4"	Entry	F109	cs288279
K253P 605 C 238 5P K4	US3	SCHL C	2-3/8"	Entry	F109	cs478004
K253P 605 C LL 5P KA4	US3	SCHL C	Less Latch	Entry	F109	cs302989
K253P 605C 234S ANSI 5P K4 KIT	US3	SCHL C	2-3/4"	Entry	F109	cs478003
K270P 605 C LL 5P KA4	US3	SCHL C	Less Latch	Classroom	F84	cs477957
K270P 605C 234S ANSI 5P K4 KIT	US3	SCHL C	2-3/4"	Classroom	F84	cs478005
K270P 605C 238S ANSI 5P K4 KIT	US3	SCHL C	2-3/8"	Classroom	F84	cs478009
K280B 605 C 234	US3	SCHL C	2-3/4"	Storeroom	F86	cs402350
K280B 605 C 238	US3	SCHL C	2-3/8"	Storeroom	F86	cs402399
K280B 605 C LL	US3	SCHL C	Less Latch	Storeroom	F86	cs303175
K280P 605 C LL 5P KA4	US3	SCHL C	Less Latch	Storeroom	F86	cs477960
K280P 605C 234S ANSI 5P K4 KIT	US3	SCHL C	2-3/4"	Storeroom	F86	cs478010
K280P 605C 238S ANSI 5P K4 KIT	US3	SCHL C	2-3/8"	Storeroom	F86	cs478011

K200 Series Cylindrical SFIC Knobsets (sold less core)

Part#	Finish	Keyway	Backset	Function	ANSI	CLK#
K253B 605 IC 234	US3	SFIC	2-3/4"	Entry	F109	cs442388
K253B 630 IC 234	US32D	SFIC	2-3/4"	Entry	F109	cs411210
K280B 630 IC 234	US32D	SFIC	2-3/4"	Storeroom	F86	cs411209

Parts & components found on page 34.

Grade 3 Cylindrical Knobsets

K300 Series Cylindrical Knobs

Part#	Finish	Keyway	Backset	Function	ANSI	CLK#
K310B 630 ADJ	US32D		2-way adj.	Passage	F75	cs288610
K310B 605 ADJ	US3		2-way adj.	Passage	F75	cs288608
K310B 609 ADJ	US5		2-way adj.	Passage	F75	cs288609
K310P 605 ADJ	US3		2-way adj.	Passage	F75	cs288611
K310P 605 LL T	US3		2-way adj.	Passage	F75	cs303052
K340B 605 ADJ	US3		2-way adj.	Privacy	F76	cs288615
K340B 609 ADJ	US5		2-way adj.	Privacy	F76	cs288616
K340B 630 ADJ	US32D		2-way adj.	Privacy	F76	cs288617
K353B 605 C ADJ	US3	SCHL C	2-way adj.	Entry	F109	cs288598
K353B 609 C ADJ	US5	SCHL C	2-way adj.	Entry	F109	cs288599
K353B 630 C ADJ	US32D	SCHL C	2-way adj.	Entry	F109	cs288600
K353P 605 C ADJ S T	US3	SCHL C		Entry	F109	cs288601
K380B 605 C ADJ	US3	SCHL C	2-way adj.	Storeroom	F86	cs288622
K380B 609 C ADJ	US5	SCHL C	2-way adj.	Storeroom	F86	cs288623
K380B 630 C ADJ	US32D	SCHL C	2-way adj.	Storeroom	F86	cs288624

Parts & components found on page 35.



K353B 630 C

K353B 609 C

K353B 605 C

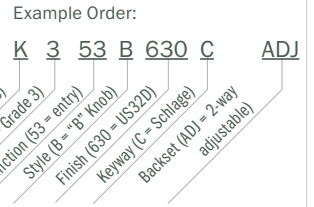

Finishes:



630
U.S. = US32D
Satin Stainless Steel

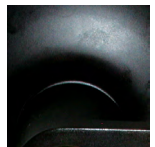

613
U.S. = US10B
Dark Bronze, Oil Rubbed



609
U.S. = US5
Antique Brass



605
U.S. = US3
Bright Brass

Features:

- ANSI A156.2 Grade 3, UL Listed, 30 min. fire rated
- 10 year mechanical warranty, 5 year finish warranty
- Solid brass cylinder, drilled 5, pinned 5
- Case Qty: 20

Deadlocks

D660 Series Grade 1

(SFIC sold less core)



D660 626

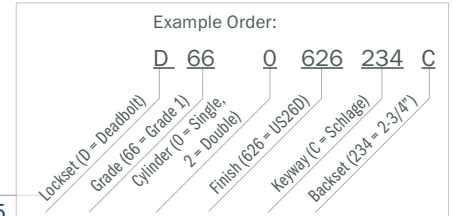

Part#	Finish	Keyway	Backset	Function	CLK#
D660 626 234 C	US26D	SCHL C	2-3/4"	Single	cs359455
D660 626 234 IC	US26D	SFIC	2-3/4"	Single	cs359456
D662 626 234 C	US26D	SCHL C	2-3/4"	Double	cs359446
D662 626 234 IC	US26D	SFIC	2-3/4"	Double	cs359447

D160 Series Grade 2

(SFIC sold less core)



D160 626



D160 613



D160 605

Part#	Finish	Keyway	Backset	Function	CLK#
D160 605 6WL C	US3	SCHL C	6-way adj.	Single	cs257037
D160 605 6WL C 5P KA4	US3	SCHL C*	6-way adj.	Single	cs477954
D160 605 6WL IC	US3	SFIC	6-way adj.	Single	cs359448
D160 609 6WL C	US5	SCHL C	6-way adj.	Single	cs473505
D160 613 6WL C	US10B	SCHL C	6-way adj.	Single	cs257038
D160 613 6WL IC	US10B	SFIC	6-way adj.	Single	cs359449
D160 626 6WL C	US26D	SCHL C	6-way adj.	Single	cs257039
D160 626 6WL IC	US26D	SFIC	6-way adj.	Single	cs359450
D160 630 6WL C	US32D	SCHL C	6-way adj.	Single	cs103126
D160 630 6WL IC	US32D	SFIC Prep	6-way adj.	Single	cs103129
D162 605 6WL C	US3	SCHL C	6-way adj.	Double	cs257031
D162 605 6WL C 5P KA4	US3	SCHL C*	6-way adj.	Double	cs477956
D162 605 6WL IC	US3	SFIC	6-way adj.	Double	cs359437
D162 609 6WL C	US5	SCHL C	6-way adj.	Double	cs485779
D162 613 6WL C	US10B	SCHL C	6-way adj.	Double	cs257032
D162 626 6WL C	US26D	SCHL C	6-way adj.	Double	cs257033
D162 626 6WL IC	US26D	SFIC	6-way adj.	Double	cs359439
D162 630 6WL C	US32D	SCHL C	6-way adj.	Double	cs103130
D162 630 6WL IC	US32D	SFIC Prep	6-way adj.	Double	cs103132

* 5-pin, Keyed-Alike 4

Parts & components found on pages 35 & 36.

Door Thickness Specifications	
Series	Inches
D660 C	1-9/16" to 2"
D662 C	1-9/16" to 2"
D660 IC	1-9/16" to 2"
D662 IC	1-9/16" to 2"
D160 C	1-3/8" to 1-3/4"
D162 C	1-3/8" to 1-3/4"
D160 IC	1-9/16" to 2"
D162 IC	1-9/16" to 2"

Features:

- ANSI A156.36 Grade 2 (D160), Grade 1 (D660), UL Listed 3-hour
- 25 year mechanical warranty, 5 year finish warranty
- Solid brass cylinder, drilled 6, pinned 6 unless noted
- Case Qty: 20

Finishes:

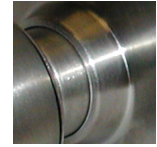

630
U.S. = US32D
Satin Stainless Steel



626
U.S. = US26D
Satin Chrome



613
U.S. = US10B
Dark Bronze, Oil Rubbed



609
U.S. = US5
Antique Brass



605
U.S. = US3
Bright Brass

Cylinders, Cores, & Housings

SFIC Cores (6-Pin & 7-Pin)

Part#	Pin	Keyway	Finish	Keying	CLK#
1A1M1 439639 control	Control Key for M KD core (DND, 2 keys)				cs106634
1A1M1 569476 control	Control Key for M KA core (DND, 2 keys)				cs106632
1A1G1 cut to 434750 control	Control Key for KA core (DND, 2 keys)				cs477968
1A1G1 cut to 452510 control	Control Key for KD core (DND, 2 keys)				cs477967
IC6B A 26D	6-pin	A KWY	US26D	uncombined	cs275719
IC6B A 4	6-pin	A KWY	US4	uncombined	cs275718
IC6B B 26D	6-pin	B KWY	US26D	uncombined	cs275723
IC6B B 4	6-pin	B KWY	US4	uncombined	cs275721
IC6B C 26D	6-pin	C KWY	US26D	uncombined	cs275726
IC6B C 4	6-pin	C KWY	US4	uncombined	cs275725
IC6B D 26D	6-pin	D KWY	US26D	uncombined	cs275734
IC6B D 4	6-pin	D KWY	US4	uncombined	cs275731
IC6B DG 26D	6-Pin	Restricted* US26D	US26D	uncombined	cs460077
IC6B DG 4	6-Pin	Restricted* US4	US4	uncombined	cs460079
IC6B E 26D	6-pin	E KWY	US26D	uncombined	cs275747
IC6B E 4	6-pin	E KWY	US4	uncombined	cs275745
IC6B F 26D	6-pin	F KWY	US26D	uncombined	cs275749
IC6B F 4	6-pin	F KWY	US4	uncombined	cs275748
IC6B G 26D	6-pin	G KWY	US26D	uncombined	cs275754
IC6B G 26D KA	6-pin	G KWY	US26D	combined KA2	cs477208
IC6B G 26D KD	6-pin	G KWY	US26D	combined KD	cs477209
IC6B G 4	6-pin	G KWY	US4	uncombined	cs275753
IC6B H 26D	6-pin	H KWY	US26D	uncombined	cs275757
IC6B J 26D	6-pin	J KWY	US26D	uncombined	cs275759
IC6B J 4	6-pin	J KWY	US4	uncombined	cs275758
IC6B K 26D	6-pin	K KWY	US26D	uncombined	cs275766
IC6B K 4	6-pin	K KWY	US4	uncombined	cs275763
IC6B L 26D	6-pin	L KWY	US26D	uncombined	cs275771
IC6B L 4	6-pin	L KWY	US4	uncombined	cs275769
IC6B M 26D	6-pin	M KWY	US26D	uncombined	cs275775
IC6B M 26D KA	6-pin	M KWY	US26D	combined KA	cs106630
IC6B M 26D KD	6-pin	M KWY	US26D	combined KD	cs106628
IC6B M 4	6-pin	M KWY	US4	uncombined	cs275773
IC6B Q 26D	6-pin	Q KWY	US26D	uncombined	cs275777
IC6B RM 26D	6-Pin	Restricted* US26D	US26D	uncombined	cs460069
IC6B RM 4	6-Pin	Restricted* US4	US4	uncombined	cs460073
IC7B A 26D	7-pin	A KWY	US26D		cs275778
IC7B B 26D	7-pin	B KWY	US26D		cs275779
IC7B C 26D	7-pin	C KWY	US26D		cs275780
IC7B D 26D	7-pin	D KWY	US26D		cs275781
IC7B DG 26D	7-Pin	Restricted* US26D	US26D	uncombined	cs460075
IC7B DG 4	7-Pin	Restricted* US4	US4	uncombined	cs460076
IC7B E 26D	7-pin	E KWY	US26D		cs275783
IC7B F 26D	7-pin	F KWY	US26D		cs275784
IC7B G 26D	7-pin	G KWY	US26D		cs275785
IC7B H 26D	7-pin	H KWY	US26D		cs275786
IC7B J 26D	7-pin	J KWY	US26D		cs275787
IC7B K 26D	7-pin	K KWY	US26D		cs275788
IC7B L 26D	7-pin	L KWY	US26D		cs275789
IC7B M 26D	7-pin	M KWY	US26D		cs275790
IC7B Q 26D	7-pin	Q KWY	US26D		cs275791
IC7B RM 26D	7-Pin	Restricted* US26D	US26D	uncombined	cs460081
IC7B RM 4	7-Pin	Restricted* US4	US4	uncombined	cs460082

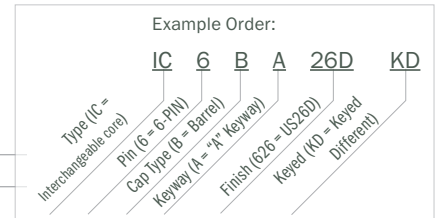

Finishes:

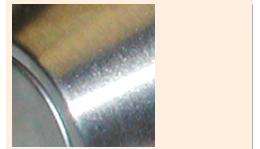

626
U.S. = US26D
Satin Chrome

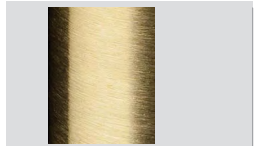

606
U.S. = US4
Satin Brass

Features:

- Solid brass construction
- Cap style
- Case Qty: 20



6-PIN 26D



7-PIN 26D

* For restricted keyway contact CLARK sales rep.

Cylinders, Cores, & Housings

Key-in-Lever / Knob Cylinders KLC1539

Part#	Size	Keyway	Finish	Keying	CLK#
KLC1539 CSA 26D KD	6 -pin	CSA	US26D	KD	cs117788
KLC1539 CSA 26D OB	6 -pin	CSA	US26D	OB	cs100262
KLC1539 CSA 4 OB	6 -pin	CSA	US4	OB	cs126168

Key-in-Lever / Knob Cylinders KLC1599

Part#	Size	Keyway	Finish	Keying	CLK#
KLC1599 CSA 26D KD	6 -pin	CSA	US26D	KD	cs313218
KLC1599 AA 26D KD	6-pin	ARROW	US26D	KD	cs256570
KLC1599 AA 26D OB	6-pin	ARROW	US26D	OB	cs256571
KLC1599 AA 4 OB	6-pin	ARROW	US4	OB	cs256568
KLC1599 CA 26D KD	6-pin	CORB 60	US26D	KD	cs256574
KLC1599 CA 26D OB	6-pin	CORB 60	US26D	OB	cs256576
KLC1599 CA 4 OB	6-pin	CORB 60	US4	OB	cs256573
KLC1599 CSA 26D OB	6 -pin	CSA	US26D	OB	cs313220
KLC1599 CSA 4 OB	6 -pin	CSA	US4	OB	cs313217
KLC1599 GA 26D KD	6-pin	SARG LA	US26D	KD	cs256578
KLC1599 GA 26D OB	6-pin	SARG LA	US26D	OB	cs483431
KLC1599 KS 26D KD	6-pin	Kwikset	US26D	KD	cs256580
KLC1599 KS 26D OB	6-pin	Kwikset	US26D	OB	cs256581
KLC1599 KS 4 OB	6-pin	Kwikset	US4	OB	cs256579
KLC1599 RB 26D KD	6-pin	RUSS D1	US26D	KD	cs256583
KLC1599 RB 26D OB	6-pin	RUSS D1	US26D	OB	cs256584
KLC1599 RB 4 OB	6-pin	RUSS D1	US4	OB	cs256582
KLC1599 SC 26D ABPR*	6-pin	SCHL C	US26D	OB	cs437330
KLC1599 SC 26D KD	6-pin	SCHL C	US26D	KD	cs256586
KLC1599 SC 26D OB	6-pin	SCHL C	US26D	OB	cs256588
KLC1599 SC 4 OB	6-pin	SCHL C	US4	OB	cs256585
KLC1599 SE 26D KD	6-pin	SCHL E	US26D	KD	cs256592
KLC1599 SE 26D OB	6-pin	SCHL E	US26D	OB	cs256595
KLC1599 SE 4 OB	6-pin	SCHL E	US4	OB	cs256590
KLC1599 SX 26D KD	6-pin	SCHL C-K	US26D	KD	cs256597
KLC1599 SX 26D OB	6-pin	SCHL C-K	US26D	OB	cs256598
KLC1599 SX 4 OB	6-pin	SCHL C-K	US4	OB	cs256596
KLC1599 WA 26D KD	6-pin	WEISER	US26D	KD	cs256601
KLC1599 WA 26D OB	6-pin	WEISER	US26D	OB	cs256602
KLC1599 WA 4 OB	6-pin	WEISER	US4	OB	cs256600
KLC1599 YA 26D KD	6-pin	YALE 8	US26D	KD	cs256605
KLC1599 YA 26D OB	6-pin	YALE 8	US26D	OB	cs256606
KLC1599 YA 4 OB	6-pin	YALE 8	US4	OB	cs256604

* bump resistant

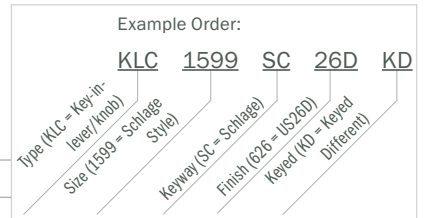

626
U.S. = US26D
Satin Chrome

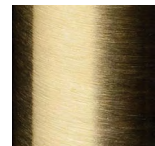

606
U.S. = US4
Satin Brass

Features:

- Solid brass construction
- 5 tailpieces
- Drilled 6, Pinned 5
- Case Qty: 10

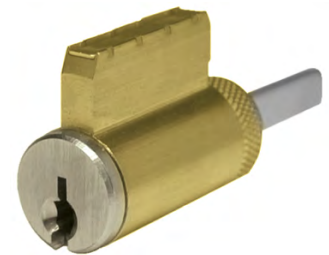

KLC1599 26D

Cylinders, Cores, & Housings

Key-in-Lever / Knob Cylinders Restricted KLC1539 - KLC1599

Part#	Size	Keyway	Finish	Keying	CLK#
KLC1539 BP 26D OB	6 -pin	Restricted*	US26D	OB	cs210482
KLC1539 BP 4 OB	6 -pin	Restricted*	US4	OB	cs210478
KLC1539 CSB 26D OB	6 -pin	Restricted*	US26D	OB	cs174324
KLC1539 JD 26D OB	6 -pin	Restricted*	US26D	OB	cs210486
KLC1539 SD 26D OB	6 -pin	Restricted*	US26D	OB	cs210488
KLC1539 SD 4 OB	6 -pin	Restricted*	US4	OB	cs210487
KLC1539 TD 26D OB	6 -pin	Restricted*	US26D	OB	cs210490
KLC1599 BP 26D OB	6 -pin	Restricted*	US26D	OB	cs313209
KLC1599 BP 4 OB	6 -pin	Restricted*	US4	OB	cs313208
KLC1599 CSB 26D OB	6 -pin	Restricted*	US26D	OB	cs313224
KLC1599 CSB 4 OB	6 -pin	Restricted*	US4	OB	cs313222
KLC1599 JD 26D OB	6 -pin	Restricted*	US26D	OB	cs313228
KLC1599 SD 26D OB	6 -pin	Restricted*	US26D	OB	cs313230
KLC1599 SD 4 OB	6 -pin	Restricted*	US4	OB	cs313229
KLC1599 TD 26D OB	6 -pin	Restricted*	US26D	OB	cs313232
KLC1599 TD 4 OB	6 -pin	Restricted*	US4	OB	cs313231

* For restricted keyway contact CLARK sales rep.

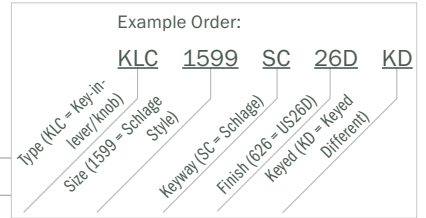

Finishes:



626
U.S. = US26D
Satin Chrome

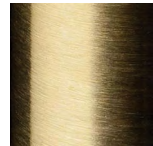

606
U.S. = US4
Satin Brass

Features:

- Solid brass construction
- 5 tailpieces
- Drilled 6, Pinned 5 (except for CSA and restricted keyways, which are drilled 6, pinned 6)
- Case Qty: 10

Cylinders, Cores, & Housings

Mortise Cylinders

Part#	Size	Keyway	Finish	Cam	Keying	CLK#
MC100 AA 26D AR KA2	1"	ARROW	US26D	Adams Rite	KA2	cs256628
MC100 KS 10B AR KA2	1"	Kwikset	US10B	Adams Rite	KA2	cs256631
MC100 KS 26D AR KA2	1"	Kwikset	US26D	Adams Rite	KA2	cs256636
MC100 KS 3 AR KA2	1"	Kwikset	US3	Adams Rite	KA2	cs256630
MC100 SC 10B AR KA2	1"	SCHL C	US10B	Adams Rite	KA2	cs256639
MC100 SC 26D AR KA2	1"	SCHL C	US26D	Adams Rite	KA2	cs256640
MC100 SC 3 AR KA2	1"	SCHL C	US3	Adams Rite	KA2	cs256638
MC100 SX 10B AR KA2	1"	SCHL C-K	US10B	Adams Rite	KA2	cs256642
MC100 SX 26D AR KA2	1"	SCHL C-K	US26D	Adams Rite	KA2	cs256644
MC100 WA 26D AR KA2	1"	WEISER	US26D	Adams Rite	KA2	cs256646
MC100 YA 10B AR KA2	1"	YALE 8	US10B	Adams Rite	KA2	cs256648
MC100 YA 26D AR KA2	1"	YALE 8	US26D	Adams Rite	KA2	cs256649
MC100 YA 3 AR KA2	1"	YALE 8	US3	Adams Rite	KA2	cs256647
MC114 CSA 10B ST OB	1-1/4"	CSA	US10B	Yale ST	OB	cs100202
MC114 CSA 26D CL KA2	1-1/4"	CSA	US26D	Corbin	KA2	cs117952
MC114 CSA 26D ST OB	1-1/4"	CSA	US26D	Yale ST	OB	cs100219
MC114 SC 10B ST/AR KA2	1-1/4"	SCHL C	US10B	Yale standard	KA2	cs256740
MC114 SC 26D ST/AR KA2	1-1/4"	SCHL C	US26D	Yale standard	KA2	cs256742
MC114 SC 3 ST KA2	1-1/4"	SCHL C	US3	Yale standard	KA2	cs256738
MC114 SX 26D ST/AR KA2	1-1/4"	SCHL C-K	US26D	Yale standard	KA2	cs256750
MC114 SX 3 ST KA2	1-1/4"	SCHL C-K	US3	Yale standard	KA2	cs256744
MC118 60 26D ST/AR KA2	1-1/8"	CORB 60	US26D	Yale ST/AR	KA2	cs428250
MC118 AA 26D ST/AR KA2	1-1/8"	ARROW	US26D	Yale ST/AR	KA2	cs256692
MC118 CSA 10B ST/AR OB	1-1/8"	CSA	US10B	Yale ST/AR	OB	cs100329
MC118 CSA 10B ST/AR KA2	1-1/8"	CSA	US10B	Yale ST/AR	KA2	cs117978
MC118 CSA 26D ST/AR OB	1-1/8"	CSA	US26D	Yale ST/AR	OB	cs110344
MC118 CSA 26D ST/AR KA2	1-1/8"	CSA	US26D	Yale ST/AR	KA2	cs117986
MC118 CSA 3 ST/AR OB	1-1/8"	CSA	US3	Yale ST/AR	OB	cs100250
MC118 GA 10B ST KA2	1-1/8"	SARG LA	US10B	Yale ST/AR	KA2	cs256693
MC118 GA 26D ST/AR KA2	1-1/8"	SARG LA	US26D	Yale ST/AR	KA2	cs256694
MC118 GA 3 ST/AR KA2	1-1/8"	SARG LA	US3	Yale ST/AR	KA2	cs286172
MC118 KS 10B ST/AR KA2	1-1/8"	Kwikset	US10B	Yale ST/AR	KA2	cs256696
MC118 KS 26D ST/AR KA2	1-1/8"	Kwikset	US26D	Yale ST/AR	KA2	cs256697
MC118 KS 3 ST/AR KA2	1-1/8"	Kwikset	US3	Yale ST/AR	KA2	cs256695
MC118 RB 10B ST/AR KA2	1-1/8"	RUSS D1	US10B	Yale ST/AR	KA2	cs256701
MC118 RB 26D ST/AR KA2	1-1/8"	RUSS D1	US26D	Yale ST/AR	KA2	cs256703
MC118 RB 3 ST/AR KA2	1-1/8"	RUSS D1	US3	Yale ST/AR	KA2	cs256699
MC118 SC 10B ST/AR KA2	1-1/8"	SCHL C	US10B	Yale ST/AR	KA2	cs256706
MC118 SC 26D ST/AR KA2	1-1/8"	SCHL C	US26D	Yale ST/AR	KA2	cs256707
MC118 SC 26D ST/AR KA2 ABPR*	1-1/8"	SCHL C	US26D	Yale ST/AR	KA2	cs437331
MC118 SC 3 ST/AR KA2	1-1/8"	SCHL C	US3	Yale ST/AR	KA2	cs256705
MC118 SE 10B ST/AR KA2	1-1/8"	SCHL E	US10B	Yale ST/AR	KA2	cs256708
MC118 SE 26D ST/AR KA2	1-1/8"	SCHL E	US26D	Yale ST/AR	KA2	cs256709
MC118 SX 10B ST/AR KA2	1-1/8"	SCHL C-K	US10B	Yale ST/AR	KA2	cs256712
MC118 SX 26D ST/AR KA2	1-1/8"	SCHL C-K	US26D	Yale ST/AR	KA2	cs256716
MC118 SX 3 ST/AR KA2	1-1/8"	SCHL C-K	US3	Yale ST/AR	KA2	cs256711
MC118 WA 26D ST/AR KA2	1-1/8"	WEISER	US26D	Yale ST/AR	KA2	cs256717
MC118 YA 26D ST/AR KA2	1-1/8"	YALE 8	US26D	Yale ST/AR	KA2	cs256720
MC118 YA 3 ST/AR KA2	1-1/8"	YALE 8	US3	Yale ST/AR	KA2	cs256719

* bump resistant

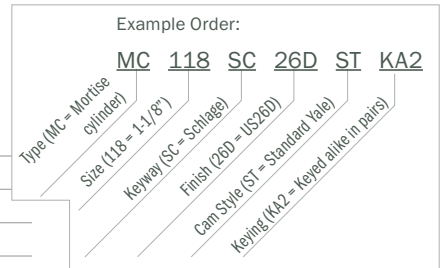

Finishes:



626
U.S. = US26D
Satin Chrome

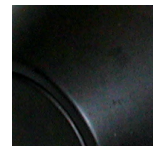

613
U.S. = US10B
Dark Bronze, Oil Rubbed



605
U.S. = US3
Bright Brass



MC118 26D



MC118 10B



MC118 3

Features:

- Solid brass construction
- 1" is drilled 5, pinned 5
- 1-1/8" and 1-1/4" cylinders are drilled 6, pinned 5 (except for CSA and restricted keyways, which are drilled 6, pinned 6)
- Case Qty: 10

Cylinders, Cores, & Housings

Mortise Cylinders Restricted

Part#	Size	Keyway	Finish	Cam	Keying	CLK#
MC114 BP 26D ST OB	1-1/4"	Restricted*	US26D	Yale ST	OB	cs210552
MC114 BP 10B ST OB	1-1/4"	Restricted*	US10B	Yale ST	OB	cs210548
MC114 BP 3 ST OB	1-1/4"	Restricted*	US3	Yale ST	OB	cs210547
MC114 CSB 10B ST OB	1-1/4"	Restricted*	US10B	Yale ST	OB	cs277525
MC114 CSB 26D ST OB	1-1/4"	Restricted*	US26D	Yale ST	OB	cs277524
MC114 JD 26D ST OB	1-1/4"	Restricted*	US26D	Yale ST	OB	cs210563
MC114 JD 3 ST OB	1-1/4"	Restricted*	US3	Yale ST	OB	cs210558
MC114 SD 26D ST OB	1-1/4"	Restricted*	US26D	Yale ST	OB	cs210569
MC114 SD 3 ST OB	1-1/4"	Restricted*	US3	Yale ST	OB	cs210566
MC114 TD 10B ST OB	1-1/4"	Restricted*	US10B	Yale ST	OB	cs210572
MC118 BP 10B ST/AR OB	1-1/8"	Restricted*	US10B	Yale ST/AR	OB	cs210517
MC118 BP 26D ST/AR OB	1-1/8"	Restricted*	US26D	Yale ST/AR	OB	cs210519
MC118 BP 3 ST/AR OB	1-1/8"	Restricted*	US3	Yale ST/AR	OB	cs210516
MC118 CSB 26D ST/AR OB	1-1/8"	Restricted*	US26D	Yale ST/AR	OB	cs174329
MC118 CSB 3 ST/AR OB	1-1/8"	Restricted*	US3	Yale ST/AR	OB	cs174327
MC118 JD 10B ST/AR OB	1-1/8"	Restricted*	US10B	Yale ST/AR	OB	cs210521
MC118 JD 26D ST/AR OB	1-1/8"	Restricted*	US26D	Yale ST/AR	OB	cs210522
MC118 JD 3 ST/AR OB	1-1/8"	Restricted*	US3	Yale ST/AR	OB	cs210520
MC118 SD 10B ST/AR OB	1-1/8"	Restricted*	US10B	Yale ST/AR	OB	cs210524
MC118 SD 26D ST/AR OB	1-1/8"	Restricted*	US26D	Yale ST/AR	OB	cs210525
MC118 SD 3 ST/AR OB	1-1/8"	Restricted*	US3	Yale ST/AR	OB	cs210523
MC118 TD 10B ST/AR OB	1-1/8"	Restricted*	US10B	Yale ST/AR	OB	cs210528
MC118 TD 26D ST/AR OB	1-1/8"	Restricted*	US26D	Yale ST/AR	OB	cs210530
MC118 TD 3 ST/AR OB	1-1/8"	Restricted*	US3	Yale ST/AR	OB	cs210527

* For restricted keyway contact CLARK sales rep.

Mortise Cylinder Parts

Part#	Description	CLK#
AMCRS-95	Mortise Cylinder Retaining Set Screw, 9.5mm	cs104890

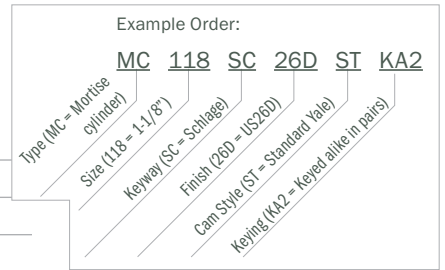

Finishes:



626
U.S. = US26D
Satin Chrome

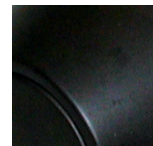

613
U.S. = US10B
Dark Bronze, Oil Rubbed



605
U.S. = US3
Bright Brass

Features:

- Solid brass construction
- 1" is drilled 5, pinned 5
- 1-1/8" and 1-1/4" cylinders are drilled 6, pinned 5 (except for CSA and restricted keyways, which are drilled 6, pinned 6)
- Case Qty: 10

Cylinders, Cores, & Housings

Rim Cylinders

Part#	Pin	Keyway	Finish	Keying	CLK#
RC6 AA 26D KA2	6-pin	ARROW	US26D	KA2	cs256763
RC6 AA 26D KD	6-pin	ARROW	US26D	KD	cs256768
RC6 AA 3 KA2	6-pin	ARROW	US3	KA2	cs256758
RC6 CSA 10B OB	6-pin	CSA	US10B	OB	cs100166
RC6 CSA 26D OB	6-pin	CSA	US26D	OB	cs100142
RC6 CSA 26D KD	6-pin	CSA	US26D	KD	cs117911
RC6 CSA 3 OB	6-pin	CSA	US3	OB	cs126182
RC6 GA 26D KD	6-pin	SARG LA	US26D	KD	cs256769
RC6 KS 10B KD	6-pin	Kwikset	US10B	KD	cs256778
RC6 KS 26D KA2	6-pin	Kwikset	US26D	KA2	cs256779
RC6 KS 26D KD	6-pin	Kwikset	US26D	KD	cs256781
RC6 KS 3 KA2	6-pin	Kwikset	US3	KA2	cs256771
RC6 KS 3 KD	6-pin	Kwikset	US3	KD	cs256774
RC6 RB 26D KA2	6-pin	RUSS D1	US26D	KA2	cs256784
RC6 SC 10B KA2	6-pin	SCHL C	US10B	KA2	cs256790
RC6 SC 10B KD	6-pin	SCHL C	US10B	KD	cs256792
RC6 SC 26D KA2	6-pin	SCHL C	US26D	KA2	cs256793
RC6 SC 26D KD	6-pin	SCHL C	US26D	KD	cs256794
RC6 SC 3 KA2	6-pin	SCHL C	US3	KA2	cs256788
RC6 SC 3 KD	6-pin	SCHL C	US3	KD	cs256789
RC6 SE 26D KA2	6-pin	SCHL E	US26D	KA2	cs256796
RC6 SX 26D KA2	6-pin	SCHL C-K	US26D	KA2	cs256799
RC6 SX 26D KD	6-pin	SCHL C-K	US26D	KD	cs256800
RC6 SX 3 KD	6-pin	SCHL C-K	US3	KD	cs256797
RC6 WA 26D KA2	6-pin	WEISER	US26D	KA2	cs256803
RC6 YA 10B KD	6-pin	YALE 8	US10B	KD	cs256807
RC6 YA 26D KA2	6-pin	YALE 8	US26D	KA2	cs256808
RC6 YA 26D KD	6-pin rim	YALE 8	US26D	KD	cs256810
RC6 YA 3 KA2	6-pin rim	YALE 8	US3	KA2	cs256804

Rim Cylinders Restricted

RC6 BP 26D OB	6-pin	Restricted*	US26D	OB	cs210577
RC6 BP 10B OB	6-pin	Restricted*	US10B	OB	cs210576
RC6 BP 3 OB	6-pin	Restricted*	US3	OB	cs210574
RC6 CSB 26D OB	6-pin	Restricted*	US26D	OB	cs174337
RC6 CSB 3 OB	6-pin	Restricted*	US3	OB	cs174335
RC6 JD 26D OB	6-pin	Restricted*	US26D	OB	cs210586
RC6 JD 3 OB	6-pin	Restricted*	US3	OB	cs210579
RC6 SD 10B OB	6-pin	Restricted*	US10B	OB	cs210588
RC6 SD 26D OB	6-pin	Restricted*	US26D	OB	cs210590
RC6 TD 10B OB	6-pin	Restricted*	US10B	OB	cs210594
RC6 TD 26D OB	6-pin	Restricted*	US26D	OB	cs210595
RC6 TD 3 OB	6-pin	Restricted*	US3	OB	cs210593

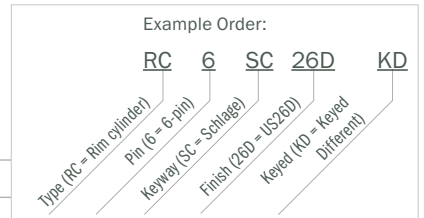

Finishes:



626
U.S. = US26D
Satin Chrome

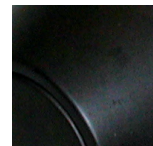

613
U.S. = US10B
Dark Bronze, Oil Rubbed



605
U.S. = US3
Bright Brass



* For restricted keyway contact CLARK sales rep.

Cylinders, Cores, & Housings

Dummy Cylinders

Part #	Size	Type	Finish	CLK#
MC100DC 26D	1"	Mortise	US26D	cs256611
MC100DC 10B	1"	Mortise	US10B	cs256610
MC100DC 3	1"	Mortise	US3	cs256609
MC118DC 10B	1-1/8"	Mortise	US10B	cs256613
MC118DC 26D	1-1/8"	Mortise	US26D	cs256614
MC118DC 3	1-1/8"	Mortise	US3	cs256612
RCDC 26D		Rim	US26D	cs287326



MC100DC 26D



MC100DC 10B



MC100DC 3

Features:

- Solid brass construction

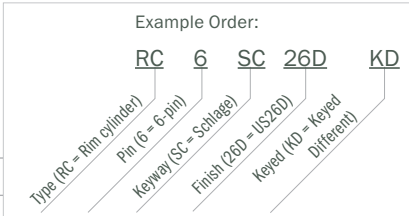

Finishes:



626
U.S. = US26D
Satin Chrome

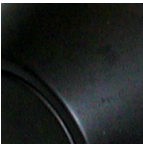

613
U.S. = US10B
Dark Bronze, Oil Rubbed

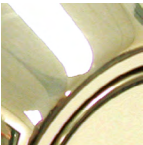

605
U.S. = US3
Bright Brass

Key Blanks

Part#	Description	CLK#
KB AR1 DND BR	Arrow, DO NOT DUP, Neuter Bow, Brass	cs459470
KB BP DND NS	6-PIN,"DO NOT DUPLICATE", Restricted*	cs209537
KB C087 DND BR	Corbin 60 5-PIN, DO NOT DUP, Neuter Bow, Brass	cs459471
KB C088 DND BR	Corbin 60 6-pin, DO NOT DUP, Neuter Bow, Brass	cs459472
KB CSA DND NS	6-PIN,"DO NOT DUPLICATE"	cs172222
KB CSA SCR NS	6-PIN,"DO NOT DUPLICATE"	cs117705
KB CSB DND NS	6-PIN,"DO NOT DUPLICATE", Restricted*	cs174339
KB DG DND NS	6-PIN,"DO NOT DUPLICATE", Restricted*	cs493871
KB JD DND NS	6-PIN,"DO NOT DUPLICATE", Restricted*	cs209538
KB KW1 DND BR	Kwikset, DO NOT DUP, Neuter Bow, Brass	cs459474
KB KW10 DND BR	Kwikset, 6-PIN, DO NOT DUP, Neuter Bow, Brass	cs106544
KB RM DND NS	6-PIN,"DO NOT DUPLICATE", Restricted*	cs493872
KB RU45 DND BR	Russ D1 5-PIN, DO NOT DUP, Neuter Bow, Brass	cs459475
KB RU46 DND BR	Russ D1 6-pin, DO NOT DUP, Neuter Bow, Brass	cs459476
KB S22 DND BR	Sargent LA 6-pin, DO NOT DUP, Neuter Bow, Brass	cs459473
	Schlage C 5-PIN, DO NOT DUP, Neuter Bow, Brass	cs459477
KB SC4 DND BR	Schlage C 6-pin, DO NOT DUP, Neuter Bow, Brass	cs459478
KB SC9 DND BR	Schlage E 6-pin, DO NOT DUP, Neuter Bow, Brass	cs459479
KB SD DND NS	6-PIN,"DO NOT DUPLICATE", Restricted*	cs209539
KB TD DND NS	6-PIN,"DO NOT DUPLICATE", Restricted*	cs209540
KB WR5 DND BR	Weiser 1555, DO NOT DUP, Neuter Bow, Brass	cs459480
KB Y1 DND BR	Yale 8, DO NOT DUP, Neuter Bow, Brass	cs459481

* For restricted keyways, contact your CLARK representative.



Features (Key Blanks):

- 50 per box, 1000 per case
- 10 per box, 100 per case
- 20 per box, 100 per case

Cylinders, Cores, & Housings

Thumb Turns

Part #	Size	Finish	Cam	CLK#
MC100TT 26D AR	1"	US26D	Adams Rite	cs256817
MC100TT 10B AR	1"	US10B	Adams Rite	cs256816
MC100TT 3 AR	1"	US3	Adams Rite	cs256815
MC114TT 26D ST	1-1/4"	US26D	Yale	cs256824
MC114TT 3 ST	1-1/4"	US3	Yale	cs256823
MC118TT 10B ST/AR	1-1/8"	US10B	Yale	cs256819
MC118TT 26D ST/AR	1-1/8"	US26D	Yale	cs256821
MC118TT 3 ST/AR	1-1/8"	US3	Yale	cs256818

Mortise Housings

Part #	Pin	Finish	Cam	CLK#	
MC-IC6-AR 26D	6-pin	US26D	Adams Rite	cs256548	
MC-IC6-AR 10B	6-pin	US10B	Adams Rite	cs256547	
MC-IC6-CL 26D	6-pin	US26D	Corbin	cs256549	
MC-IC6-SL 10B	6-pin	US10B	Schlage	cs465477	
MC-IC6-SL 26D	6-pin	US26D	Schlage	cs465474	
MC-IC6-ST 26D	6-pin	US26D	Standard	cs256550	
MC-IC7-AR 10B	7-pin	US10B	Adams Rite	cs256551	
MC-IC7-AR 26D	7-pin	US26D	Adams Rite	cs256552	
MC-IC7-CL 26D	7-pin	US26D	Corbin	cs256553	
MC-IC7-SA 26D	7-pin	US26D	Sargent	cs256554	
MC-IC7-SL 10B	7-pin	US10B	Schlage	cs463694	
MC-IC7-SL 26D	7-pin	US26D	Schlage	cs256555	
MC-IC7-SL 3	7-pin	US3	Schlage	cs463692	
MC-IC7-ST 10B	7-pin	US10B	Standard	cs256556	
MC-IC7-ST 26D	7-pin	US26D	Standard	cs256557	
MC-IC7-ST 3	7-pin	US3	Standard	cs463696	
MCT-IC6-AR 26D	6-pin	Tapered	US26D	Adams Rite	cs256558
MCT-IC7-AR 10B	7-pin	Tapered	US10B	Adams Rite	cs256559
MCT-IC7-AR 26D	7-pin	Tapered	US26D	Adams Rite	cs256560

Rim Housings

Part #	Pin	Type	Finish	Tailpiece Style	CLK#
RC-IC6 26D	6-pin	Rim	US26D	Rigid	cs256561
RC-IC7 10B	7-pin	Rim	US10B	Rigid	cs256563
RC-IC7 26D	7-pin	Rim	US26D	Rigid	cs256564
RC-IC7 3	7-pin	Rim	US3	Rigid	cs256562
RC-IC7-LZ 26D	7-pin	Rim	US26D	Lazy Motion	cs435390

Finishes:



626
U.S. = US26D
Satin Chrome



613
U.S. = US10B
Dark Bronze, Oil Rubbed



605
U.S. = US3
Bright Brass



MC100TT 26D



MC-IC 26D

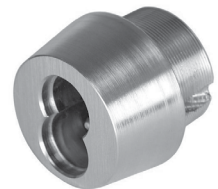

MCT-IC 26D



RC-IC 26D

Cylinders, Cores, & Housings

Cams

AR CAM	Adams Rite CAM for STD Mortise Cylinder	cs269979
AR-IC CAM	Adams Rite CAM for IC Mortise Housing	cs269980
CL CAM	Cloverleaf CAM for STD Mortise Cylinder	cs269981
CL-IC CAM	Cloverleaf CAM for IC Mortise Housing	cs269982
IC-SP1	Spacer for I/C Cylinder Shell	cs321778
RCTP	Rim Tailpiece for Standard Cylinder	cs471691
SA CAM	Sargent CAM for STD Mortise Cylinder	cs269984
SA-IC CAM	Sargent CAM for IC Mortise Housing	cs269986
SL CAM	Schlage "L" CAM for STD Mortise Cylinder	cs269988
SL-IC CAM	Schlage "L" CAM for IC Mortise Housing	cs269989
ST CAM	Yale STD CAM for STD Mortise Cylinder	cs269990
ST-IC CAM	Yale STD CAM for IC Mortise Housing	cs269992

Collars

CR-1 26D	5/32" Solid Mortise Cylinder Collar, US26D	cs270421
CR-1 10B	5/32" Solid Mortise Cylinder Collar, US10B	cs270420
CR-1 3	5/32" Solid Mortise Cylinder Collar, US3	cs270417
CR-2 10B	1/8" Mortise Cylinder Trim Ring, US10B	cs270423
CR-2 26D	1/8" Mortise Cylinder Trim Ring, US26D	cs270424
CR-2 3	1/8" Mortise Cylinder Trim Ring, US3	cs270422
CR-3 10B	1/4" Adjust Mortise Cylinder Collar, US10B	cs270427
CR-3 26D	1/4" Adjust Mortise Cylinder Collar, US26D	cs270429
CR-3 3	1/4" Adjust Mortise Cylinder Collar, US3	cs270425

Finishes:



626
U.S. = US26D
Satin Chrome



613
U.S. = US10B
Dark Bronze, Oil Rubbed



605
U.S. = US3
Bright Brass

Features (Cams & Collars):

- 100 per case

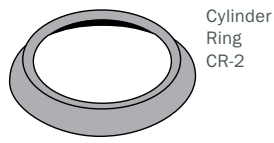
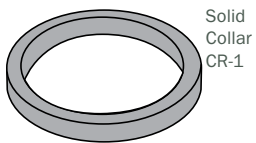
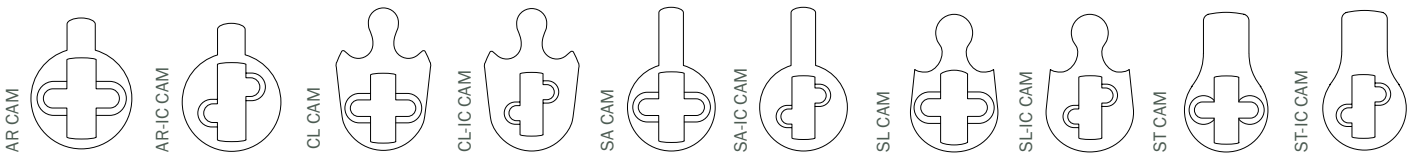

Builders Hardware

Push, Pull & Kick Plates

Part#	Description / Dimensions / Finish	CLK#
BH-70-630	Push / 3-1/2"x15" / US32D	cs422332
BH-71-630	Push / 4"x16" / US32D	cs422252
BH-7010-630	Pull / *5-1/2", 3-1/2"x15" / US32D	cs422325
BH-7110-630	Pull / *5-1/2", 4"x16" / US32D	cs422249
BH-7116-630	Pull / *8", 4"x16" / US32D	cs422250
BH-10x34-630	Kick Plate / 10"x34", 0.05 Thickness / US32D	cs422226
BH-8x34-630	Kick Plate / 8"x34", 0.05 Thickness / US32D	cs422256
BH-70-628	Push / 3-1/2"x15" / US28	cs422248
BH-71-628	Push / 4"x16" / US28	cs422251
BH-7010-628	Pull / *5-1/8", 3-1/2"x15" / US28	cs422247
BH-70-613	Push / 3-1/2"x15" / US10B	cs422331
BH-7010-613	Pull / 5-1/2", 3-1/2"x15" / US10B	cs422324
BH-70-605	Push / 3-1/2"x15" / US3	cs422329
BH-7010-605	Pull / 5-1/8", 3-1/2"x15" / US3	cs422323

* center to center

Finishes:

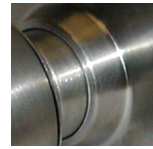

630
U.S. = US32D
Satin Stainless Steel



628
U.S. = US28
Aluminum

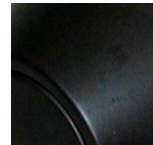

613
U.S. = US10B
Dark Bronze, Oil Rubbed



605
U.S. = US3
Bright Brass

BP = Brass Plated

PC = Prime Coat

SL = Silver

Hole Filler Plates

Part#	Description / Dimensions / Finish	CLK#
BH-AR-335-630	3-1/2" dia., allows for use of levers on 1-3/8" door / US32D	cs422262
BH-AR-335-613	3-1/2" dia., allows for use of levers on 1-3/8" door / US10B	cs422261
BH-BF-135-PC	Covers up to a 3-3/4" dia. / PC	cs422263
BH-BF-161-BP	Covers up to a 2-1/8" dia. / BP	cs422264
BH-BF-161-PC	Covers up to a 2-1/8" dia. / PC	cs422265
BH-BF-161-SL	Covers up to a 2-1/8" dia. / SL	cs422266
BH-BF-178-PC	Covers up to a 1-1/2" dia. / PC	cs422267
BH-BF-178-SL	Covers up to a 1-1/2" dia. / SL	cs422268
BH-PDF-161-PC	Covers up to 2-1/8" hole under rim panic device / PC	cs422322

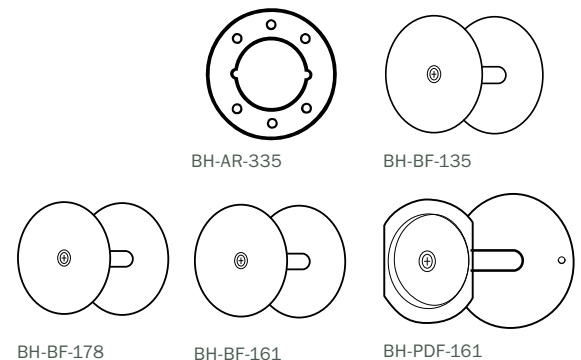
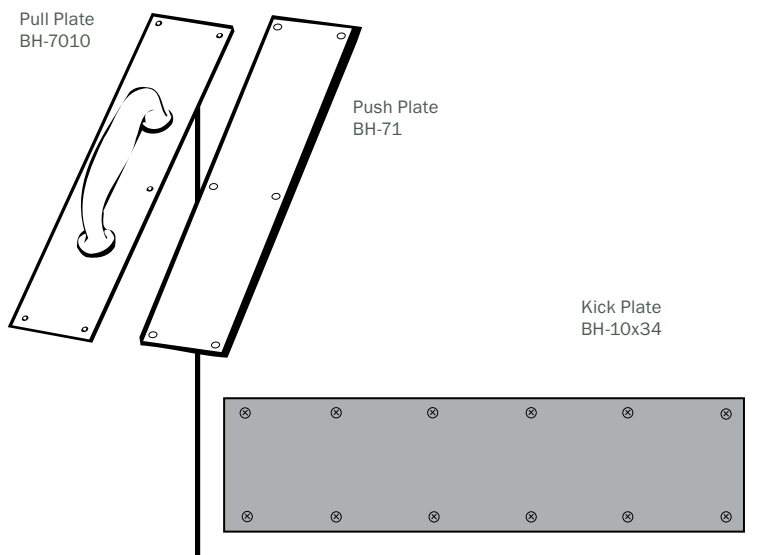

Builders Hardware

Filler Plates

Part#	Description / Dimensions / Finish	CLK#
BH-AF-260-SL	Aluminum Frame, Electric strike filler, 4-7/8" x1-1/4" / SL	cs422257
BH-AF-261-SL	Aluminum Frame, Electric strike filler, 4-7/8" x1-1/4" / SL	cs422258
BH-BTS-160-PC	T-strike with 160 cut out, 2-3/4" x 1-3/8" / PC	cs422272
BH-CV-86	Converts 86 cut out to 161, 8" x 1-1/4" / PC	cs422281
BH-EF-160	160 cut out, 2-1/4" x 1" / PC	cs422284
BH-EF-161	161 cut out, 2-1/4" x 1-1/8" / PC	cs422285
BH-EF-161-S	161 cut out, 2-3/4" x 1-1/8" / PC	cs422286
BH-EF-634	6-3/4" x1", flush bolt cut out / PC	cs422287
BH-EF-86	86 cut out, 8" x 1-1/4" x 3/16" / PC	cs422288
BH-FF-45	Frame hinge cut out, 4-1/2" x 1-5/8" / PC	cs422292
BH-FPK-161	Filler Plate Kit, FOR 161 CUT OUT / PC	cs422293
BH-FPK-86	Filler Plate Kit, FOR 86 CUT OUT / PC	cs422294
BH-FS-260-PC	Strike filler, 4-7/8" x 1-1/4" / PC	cs422295
BH-HF-45	Door hinge cut out, 4-1/2" x 1-3/4" / PC	cs422296
BH-HS-060	16-gauge, hinge shim, 4-1/2" / PC	cs422297
BH-HS-090	13-gauge, hinge shim, 4-1/2" / PC	cs422298
BH-SHF-45	Door hinge cut out, 4-1/2" x 1-1/2" / PC	cs422341

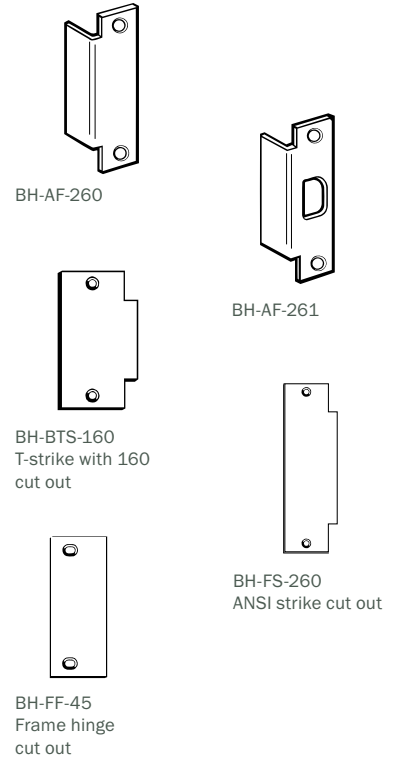

Scar Plates

Part#	Description / Dimensions / Finish	CLK#
BH-DSP-135-630	Fits under deadbolt collars, converts 2-3/8" to 2-3/4" / US32D	cs422283
BH-DSP-135-605	Fits under deadbolt collars, converts 2-3/8" to 2-3/4" / US3	cs422282
BH-SP-135-605	Knob scar plate, converts 2-3/8" - 2-3/4" / US3	cs422344
BH-SP-135-609	Knob scar plate, converts 2-3/8" - 2-3/4" / US5	cs422345
BH-SP-135-630	Knob scar plate, converts 2-3/8" - 2-3/4" / US32D	cs422346

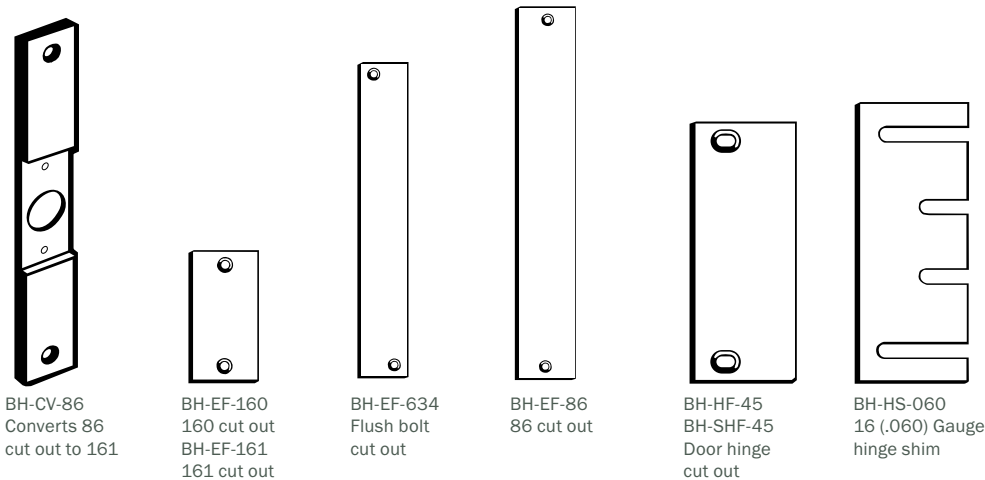
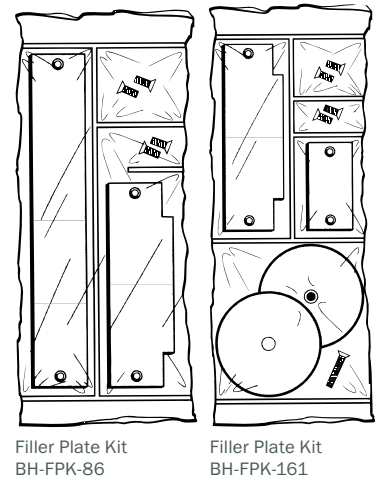

BH-CV-86
Converts 86
cut out to 161

BH-EF-160
160 cut out
BH-EF-161
161 cut out

BH-EF-634
Flush bolt
cut out

BH-EF-86
86 cut out

BH-HF-45
BH-SHF-45
Door hinge
cut out

BH-HS-060
16 (.060) Gauge
hinge shim

Scar Plate
BH-SP-135

Scar Plate
BH-DSP-135

Builders Hardware

Remodeling Wrap Plates

Part#	Description / Dimensions / Finish	CLK#
BH-1-S-CW	2-3/8", 1-3/8", 2-1/8", 4" x 9" / US32D	cs422233
BH-1-PB-CW	2-3/8", 1-3/8", 2-1/8", 4" x 9" / US3	cs422232
BH-12-2-S-CW	2-3/4", 1-3/4", 2-1/8", 4-3/4" x 12" / US32D	cs422227
BH-14-2-S-CW	2-3/4", 1-3/4", 5" x 14" / US32D	cs422228
BH-14-S-CW	2-3/4", 1-3/4", 5" x 14" / US32D	cs422230
BH-15-S-CW	2-3/4", 1-3/4", 5" x 15", Simplex 1000 / US32D	cs422231
BH-2-PB-CW	2-3/8", 1-3/4", 2-1/8", 4" x 9" / US3	cs422236
BH-2-S-CW	2-3/8", 1-3/4", 2-1/8", 4" x 9" / US32D	cs422237
BH-20-S-CW	2-3/4", 1-3/4", 2-1/8", 5" x 20" / US32D	cs422234
BH-27-S-CW	2-3/4", 1-3/4", 5" x 15", Alarm Lock Trilogy / US32D	cs422235
BH-3-PB-CW	2-3/4", 1-3/8", 2-1/8", 4-1/4" x 9" / US3	cs422239
BH-4-PB-CW	2-3/4", 1-3/4", 2-1/8", 4-1/4" x 9" / US3	cs422241
BH-4-S-2-CW	2-3/4", 1-3/4", 2-1/8", 4-3/4" x 9" / US32D	cs422242
BH-4-S-CW	2-3/4", 1-3/4", 2-1/8", 4-1/4" x 9" / US32D	cs422243
BH-40-S-CW	1-3/4", 4-1/4" x 9", Blank Plate / US32D	cs422240
BH-504-S-CW	1-3/4", 5" x 12", Mortise 86 cut-out / US32D	cs422244
BH-51-PB-CW	2-3/8", 1-3/8", 2-1/8", 4" x 4-1/2" / US3	cs422245
BH-61-PB-CW	2-3/8", 1-3/4", 2-1/8", 4" x 4-1/2" / US3	cs422246
BH-80-S-CW	1-3/4", 4-1/2" x 4-1/2", Blank Plate / US32D	cs422253
BH-81-PB-CW	2-3/4", 1-3/4", 2-1/8", 4-1/4" x 4-1/2" / US3	cs422254
BH-81-S-CW	2-3/4", 1-3/4", 2-1/8", 4-1/4" x 4-1/2" / US32D	cs422255

Finishes:

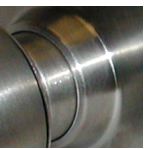

630
U.S. = US32D
Satin Stainless Steel



605
U.S. = US3
Bright Brass

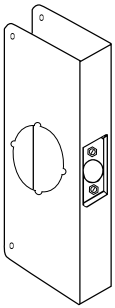

BH-1-PB-CW
BH-1-S-CW

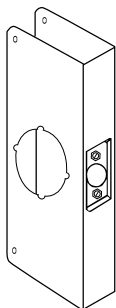

BH-2-PB-CW
BH-2-S-CW

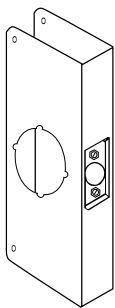

BH-3-PB-CW

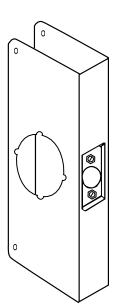

BH-4-PB-CW
BH-4-S-CW

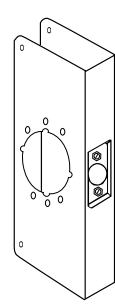

BH-4-S-2-CW

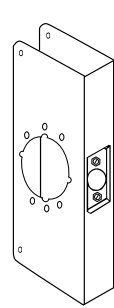

BH-12-2-S-CW

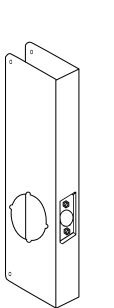

BH-14-S-CW

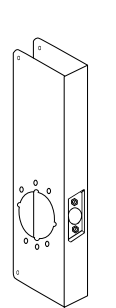

BH-14-2-S-CW

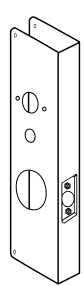

BH-15-S-CW

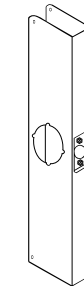

BH-20-S-CW

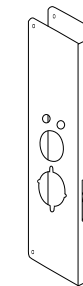

BH-27-S-CW

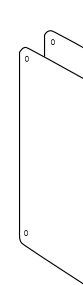

BH-40-S-CW
BH-80-S-CW

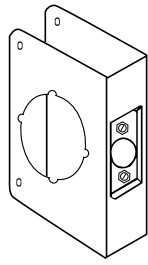

BH-51-PB-CW
BH-61-PB-CW
BH-81-PB-CW
BH-81-S-CW

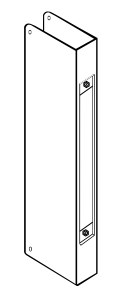

BH-504-S-CW

Exit Devices

ED2300 Series

Part#	Description / Finish	CLK#
ED2300R-F 689 36"	Fire Rated, 36" / ALUM	cs380429
ED2300R-F 695 36"	Fire Rated, 36" / DURO	cs380433
ED2300R-P 630 36"	Panic, 36" / Satin Stainless Steel	cs106521
ED2300R-P 689 36"	Panic, 36" / ALUM	cs380439
ED2300R-P 689 48"	Panic, 48" / ALUM	cs380442
ED2300R-P 695 36"	Panic, 36" / DURO	cs380444
ED2300R-P 695 48"	Panic, 48" / DURO	cs410995
ED2300V-P 689 36"	Surf Vertical Rod, Panic, 36" x 84" / ALUM	cs380475
ED2300V-P 695 36"	Surf Vertical Rod, Panic, 36" x 84" / DURO	cs380476

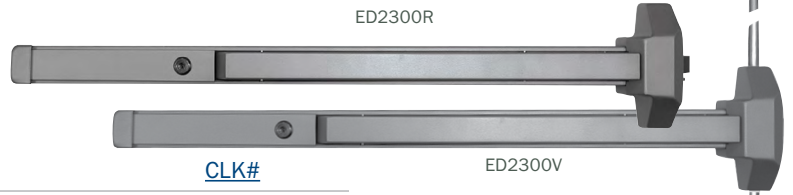

ED2300 Series Trims

ED23T-CRC	Cylinder retaining cup for P01-NL and PET-NL /	cs485412
ED23T-FP01-NL 689	Finger Pull, Storeroom (Night Latch), Less CYL / ALUM	cs480203
ED23T-FP01-NL 695	Finger Pull, Storeroom (Night Latch), Less CYL / DURO	cs480207
ED23T-KIK-CLS 630	Key-in-knob, Classroom / SCHL C / US32D	cs480213
ED23T-KIK-NL 630	Key-in-knob, Storeroom (Night Latch) / SCHL C / US32D	cs480214
ED23T-KIL-CLS 626	Key-in-lever, Classroom / SCHL C / US26D	cs380481
ED23T-KIL-CLS 626 IC	Key-in-lever, Classroom / SFIC / US26D	cs101056
ED23T-KIL-CLS 695	Key-in-lever, Classroom / SCHL C / DURO	cs402392
ED23T-KIL-NL 626	Key-in-lever, Storeroom Rigid (Night Latch) / SCHL C / US26D	cs450557
ED23T-KIL-NL 626 IC	Key-in-lever, Storeroom Rigid (Night Latch) / SFIC / US26D	cs101057
ED23T-KIL-NL 695	Key-in-lever, Storeroom Rigid (Night Latch) / SCHL C / DURO	cs450558
ED23T-LET-CLS 626	Escutcheon, Classroom / US26D	cs448442
ED23T-LET-CLS 695	Escutcheon, Classroom / DURO	cs448443
ED23T-LET-NL 626	Escutcheon, Storeroom (Night Latch) / US26D	cs449351
ED23T-LET-NL 695	Escutcheon, Storeroom (Night Latch) / DURO	cs449352
ED23T-P01 689	Pull Only, No CYL / ALUM	cs380483
ED23T-P01 695	Pull Only, No CYL / DURO	cs380484
ED23T-P01-NL 689	Pull, Storeroom (Night Latch), Less CYL / ALUM	cs380486
ED23T-P01-NL 695	Pull, Storeroom (Night Latch), Less CYL / DURO	cs380487
ED23T-PET-NL 630	Pull, Escutcheon, Storeroom (Night Latch), Less CYL / US32D	cs480215
ED23T-PET-NL 695	Pull, Escutcheon, Storeroom (Night Latch), Less CYL / DURO	cs505977
ED23T-PET-TP 630	Pull, Escutcheon, Classroom (Thumb Piece), Less CYL / US32D	cs480217
ED23T-PET-TP 695	Pull, Escutcheon, Classroom (Thumb Piece), Less CYL / DURO	cs505978

Finishes:



630
U.S. = US32D
Satin Stainless Steel



626
U.S. = US26D
Satin Chrome



689
-
Aluminum

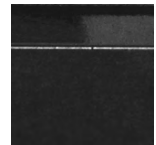

695
-
Dark Bronze

Features:

- ANSI A156.3 Grade 1, UL Listed Panic Device, UL Listed 3-hour Fire Device
- Non-handed
- Trim sold separately
- 10-year warranty
- Case Qty: 6

Parts & components found on page 38.



ED23T-FP01-NL

ED23T-CRC

ED23T-P01-NL 695

ED23T-P01 689

ED23T-LET 626

ED23T-KIL-CLS 626

ED23T-PET-NL 630

ED23T-PET-TP 630

ED23T-KIK-CLS 630

Storefront Hardware

Part#	Description / Faceplate / Finish	CLK#
ADB118 AL/DU	1-1/8" B.S. Deadbolt / 2FLAT & 2RAD / ALUM & DURO	cs418625
ADB3132 AL/DU	31/32" B.S. Deadbolt / 2FLAT & 2RAD / ALUM & DURO	cs418626
ADL118 AL/DU	1-1/8" B.S. Deadlatch / 2FLAT & 2RAD / ALUM & DURO	cs418639
ADL3132 AL/DU	31/32" B.S. Deadlatch / 2FLAT & 2RAD / ALUM & DURO	cs418643
AHB118 AL/DU	1-1/8" B.S. Hookbolt / 2FLAT & 2RAD / ALUM & DURO	cs418619
AHB3132 AL/DU	31/32" B.S. Hookbolt / 2FLAT & 2RAD / ALUM & DURO	cs418624



ADLS-LS2H



ADLS-SS1H

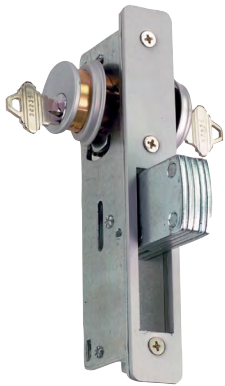

ADB118 AL



ADL118 AL



AHB118 AL

Locks shown with cylinders and AL1 lever handle



AEXIN-AL



AEXIN-DU



Part#	Description / Finish	CLK#
ACD	Cam Disc (Plug), Reversible for Lever and Push/Pull Handle	cs479614
ADB2P	US26D / Two Point Deadbolt	cs103072
ADLS-LS2H	Long, 2-Hole, Flat, Strike / US32D	cs101794
ADLS-SS1H	Short, 1-Hole, Flat, Strike / US32D	cs101795
AEXIN-AL	Lock Indicator / ALUM	cs428843
AEXIN-DU	Lock Indicator / DURO	cs428844
AFB14-AL	1/4" B.S. Flushbolt, Holes 5-7/32" center to center, between mounting screws / ALUM	cs428846
AFB14-DU	1/4" B.S. Flushbolt, Holes 5-7/32" center to center, between mounting screws / DURO	cs428851
AFB18-AL	1/8" B.S. Flushbolt, Holes 5-7/32" center to center, between mounting screws / ALUM	cs428852
AFB18-DU	1/8" B.S. Flushbolt / DURO	cs428853
AHDB-DD	Header Bolt	cs101791
AHDB118	Header Bolt	cs101792
AHS	2 Signs	cs448071
AL1-AL	Lever, LH/RH / ALUM	cs418584
AL1-DU	Lever, LH/RH / DURO	cs418588
AP1 AL	Push/Pull / ALUM	cs418602
AP1 DU	Push/Pull / DURO	cs418605
AP1RS	Paddle Return Spring Kit, All 4 Springs	cs105067
ATDB	Threshold Bolt	cs101793

THIS DOOR TO REMAIN UNLOCKED

WHEN THE BUILDING IS OCCUPIED

AHS 1 of 2 signs
Other sign states:
THIS DOOR TO REMAIN UNLOCKED
DURING BUSINESS HOURS



ATDB



AHDB118

Features (Storefront):

- Case Qty(s):
Flush Bolts = 10
Locks = 25
Levers = 30
Paddles = 20

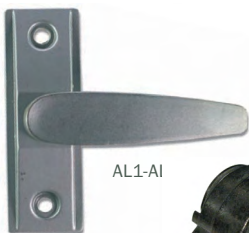

AL1-AL



AP1 AL



AFB-AL



AHDB-DD



AP1RS

Storefront Hardware - Pivots

Part#	Finish / Description	CLK#
APV-8 AL	Aluminum / Offset Pivot Set	cs103107
APV-8 DU	Duranodic / Offset Pivot Set	cs103108
APV-10 LH AL	Aluminum / Pivot Set, 3/4" Offset, LH	cs103110
APV-10 LH DU	Duranodic / Pivot Set, 3/4" Offset, LH	cs103111
APV-10 RH AL	Aluminum / Pivot Set, 3/4" Offset, RH	cs103112
APV-10 RH DU	Duranodic / Pivot Set, 3/4" Offset, RH	cs103113

Finishes:

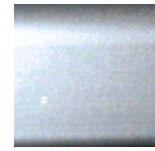

628
U.S. = US28
Aluminum



313
Duranodic

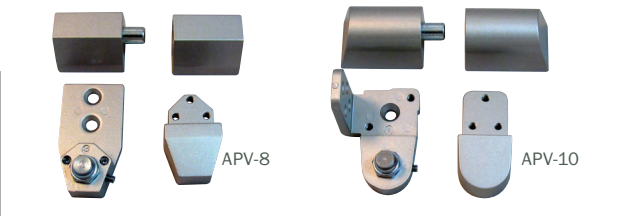

Exit Devices

ED1000 Series Narrow Stile

Part#	Description / Finish	CLK#
ED1048CV-628	Concealed Vertical Rod, 48" x 84" / US28	cs428868
ED1048R-LHR-628	RIM, 48", LHR / US28	cs428870
ED1048R-RHR-628	RIM, 48", RHR / US28	cs428906
ED1048CV-313	Concealed Vertical Rod, 48" x 84" / DURO	cs428867
ED1048R-LHR-313	RIM, 48", LHR / DURO	cs428869
ED1048R-RHR-313	RIM, 48", RHR / DURO	cs428904



Parts & components found on page 34.

Features:

- UL Listed
- Rim device is handed. CV device is reversible
- 1-year warranty
- Case Qty: 6

ED1048CV

Door Closer

Overhead Concealed

Part#	Function / Style / Size	CLK#
C3600-OH-105-HO-S	105° Hold Open, S ARM / Size 3	cs421968
C3600-OH-105-NHO-S	105° Non-Hold Open, S ARM / Size 3	cs421969
C3600-OH-90-HO-S	90° Hold Open, S ARM / Size 3	cs428907
C3600-OH-90-NHO-S	90° Non-Hold Open, S ARM / Size 3	cs428908
C3700-OH-105-HO-S	105° Hold Open, S ARM ADA / ADJ 1-4	cs479610
C3700-OH-105-NHO-PT	105° Non-Hold Open, PT arm (end-loading 7/8") ADA / ADJ 1-4	cs102263
C3700-OH-105-NHO-S	105° Non-Hold Open, S ARM ADA / ADJ 1-4	cs479611
C3700-OH-90-HO-S	90° Hold Open, S ARM ADA / ADJ 1-4	cs479612
C3700-OH-90-NHO-S	90° Non-Hold Open, S ARM ADA / ADJ 1-4	cs479613



C3600-OH

Features:

- 10-year warranty
- Non-handed, center hung
- Side load arm and pivot set included, except PT model in which a 7/8" end load arm and pivot set are included.
- Cast iron body, hardened steel internal springs, closer fluid non-gumming and non-freezing
- Medium spring power (C3600)
- Adjustable Spring Power (C3700)
- Case Qty: 4

See page 37 for additional arm types

Door Closers

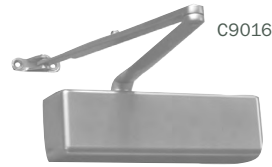

C9000 Series Surface - Adjustable Size

Part#	Function / Style	Size	Finish	CLK#
C9016 689	TRI-PK	ADJ 1-6	ALUM	cs336794
C9016 695	TRI-PK	ADJ 1-6	DURO	cs336795

C7000 Series Surface - Adjustable Size

C7316 689	TRI-PK, SLIM COVER	ADJ 1-6	ALUM	cs275078
C7316 695	TRI-PK, SLIM COVER	ADJ 1-6	DURO	cs275079
C7516 689	TRI-PK, FULL COVER	ADJ 1-6	ALUM	cs275083
C7516 695	TRI-PK, FULL COVER	ADJ 1-6	DURO	cs275084

C5000 Series Surface - Adjustable Size

C5014 689	TRI-PK	ADJ 1-4	ALUM	cs275073
C5014 695	TRI-PK	ADJ 1-4	DURO	cs275074
C5016 689	TRI-PK	ADJ 1-6	ALUM	cs104747
C5016 695	TRI-PK	ADJ 1-6	DURO	cs104748
C5036 689	TRI-PK	ADJ 3-6	ALUM	cs420635
C5036 695	TRI-PK	ADJ 3-6	DURO	cs420636

Features:

- ANSI 156.4 Grade 1, UL Listed and UL 10C, Meets ADA requirements when adjusted to size 1
- C9000 series 25-year warranty, C7000 series 10-year warranty, C5000 series 5-year warranty
- Standard sweep, latching and back-check adjustment valves
- Cast aluminum body (C9000 is cast iron body), closer fluid non-gumming and non-freezing
- Maximum reveal depth 4"
- Case Qty(s): C9000= 4
C7000= 4
C5000= 10

Parts & components found on page 37.

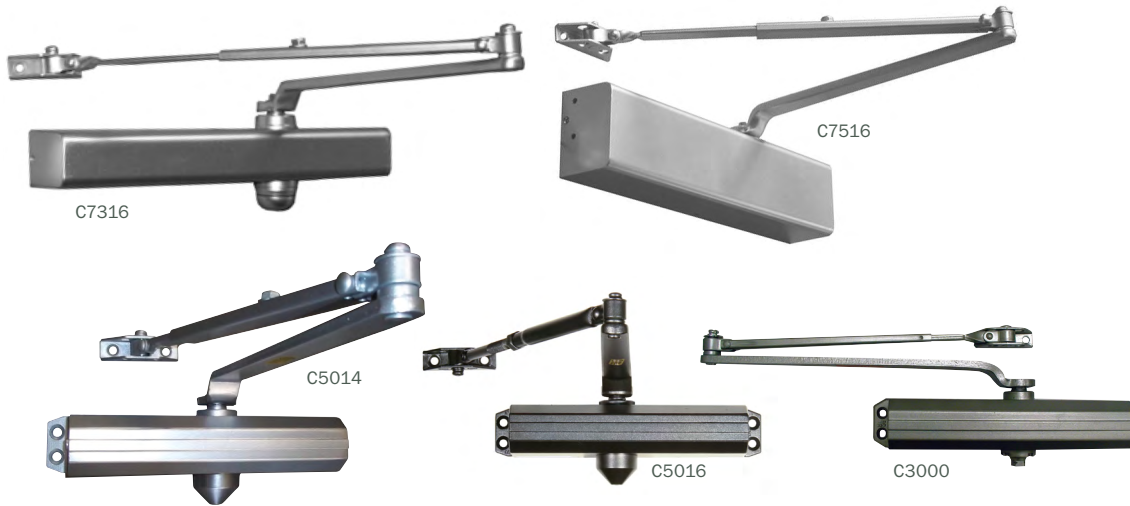

Finishes:



689
-
Aluminum

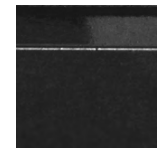

695
-
Dark Bronze

C3000 Series Surface - Sized

Part#	Function / Style	Size	Finish	CLK#
C3003-689	TRI-PK	SIZE 3	ALUM	cs428858
C3003-695	TRI-PK	SIZE 3	DURO	cs428859
C3004-689	TRI-PK	SIZE 4	ALUM	cs428860
C3004-695	TRI-PK	SIZE 4	DURO	cs428861

Features:

- ANSI 156.4 Grade 1; UL Listed and UL 10C
- 5-year warranty
- Case Qty: 10

Door Closers Technical Dimensions

C9000 Series Surface

Description	Dimensions
A. Length of closer body	11" (280mm)
B. Horizontal mounting holes	1" (25.4mm)
C. Vertical mounting holes	2-1/4" (57mm)
D. Closer body height	2-3/4" (70mm)
E. Projection from door	2" (51mm)

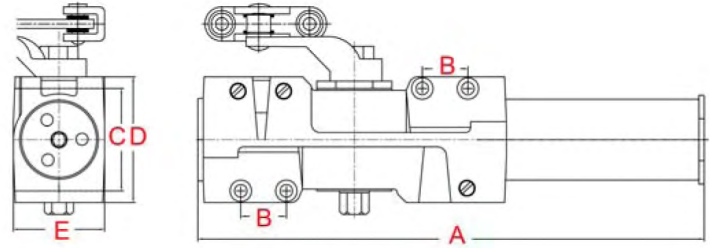

C7000 Series Surface

Description	Dimensions
A. Length of closer body	12-3/4" (324mm)
B. Horizontal mounting holes	12" (304.8mm)
C. Vertical mounting holes	3/4" (19mm)
D. Closer body height	1-3/4" (45mm)
E. Projection from door	2-3/16" (56mm)

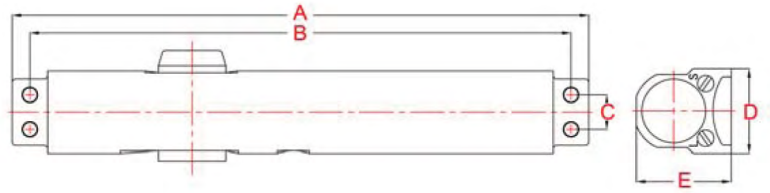

C5000 Series Surface

Description	Dimensions
A. Length of closer body	9-3/4" (248mm)
B. Horizontal mounting holes	9-1/16" (230mm)
C. Vertical mounting holes	3/4" (19mm)
D. Closer body height	1-13/16" (46mm)
E. Projection from door	2-3/4" (70mm)

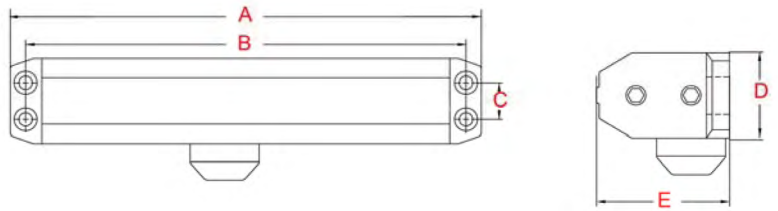

C3000 Series Sized

Description	Dimensions	
	C3003	C3004
A. Length of closer body	8-7/8" (225mm)	9-3/4" (248mm)
B. Horizontal mounting holes	8-3/16" (208mm)	9-1/16" (230mm)
C. Vertical mounting holes	3/4" (19mm)	3/4" (19mm)
D. Closer body height	1-32/32" (50mm)	1-13/16" (46mm)
E. Projection from door	2-29/32" (73mm)	2-3/4" (70mm)

Brass Rekeyable Padlocks

PL450 Premium Brass Rekeyable Padlock

- Solid brass body and cylinder with chrome plated shackle provide superior corrosion resistance
- Keyable to most door lock cylinder keying systems using standard cylinder format (included cylinder drilled for 6-pins, pinned to 5)
- Hardened steel shackle and double-ball locking to resist cutting and prying
- Key-retaining and non-key-retaining offered, but easily convertible either way
- Shackle easily changed
- Boxed individually in shelf packs of 6 with 36 per master carton

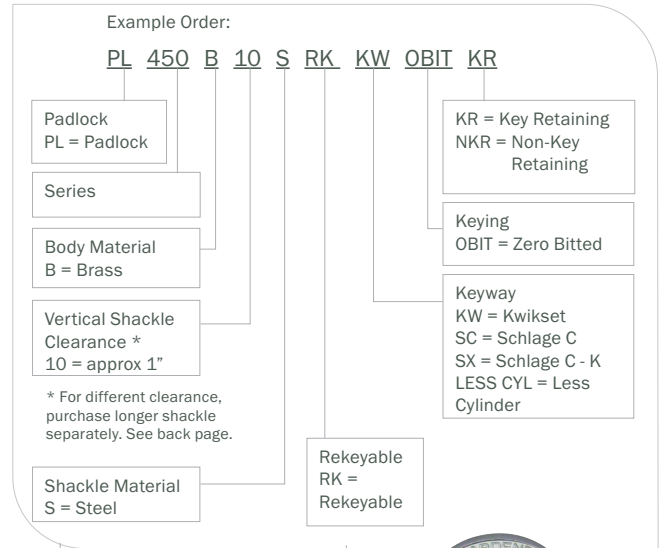

Part#	CLK#	Width	Thickness	Shackle Diameter	Vertical Clearance	Horizontal Clearance
PL450B10S RK KW OBIT KR	cs480996	1-3/4"	13/16"	5/16"	1"	5/16"
PL450B10S RK KW OBIT NKR	cs480997	1-3/4"	13/16"	5/16"	1"	5/16"
PL450B10S RK LESS CYL W/DRVR	cs480998	1-3/4"	13/16"	5/16"	1"	5/16"
PL450B10S RK SC OBIT KR	cs480999	1-3/4"	13/16"	5/16"	1"	5/16"
PL450B10S RK SC OBIT NKR	cs481000	1-3/4"	13/16"	5/16"	1"	5/16"
PL450B10S RK SX OBIT KR	cs481001	1-3/4"	13/16"	5/16"	1"	5/16"
PL450B10S RK SX OBIT NKR	cs481002	1-3/4"	13/16"	5/16"	1"	5/16"



PL450B10S

PL400/300/200 Standard Brass Padlocks

- Solid brass body and parts along with chrome plated shackle prevent corrosion
- Hardened steel shackle resists cutting
- Non-key-retaining
- K120/1092VB (PL200) and K130/1092DS (PL300 & PL400) keyways
- Attractive blister pack supports retail sales
- Individually packed in shelf packs of 6 with 72 per master carton
- Original key blanks available. See page 32.

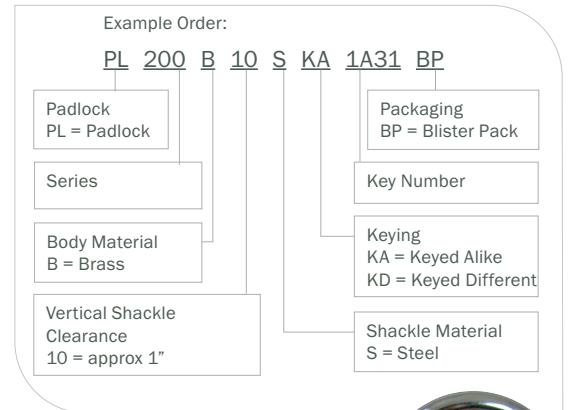

Part#	CLK#	Width	Thickness	Shackle Diameter	Vertical Clearance	Horizontal Clearance
PL200B10S KA 1A31 BP	cs503848	3/4"	3/8"	1/8"	7/16"	3/8"
PL200B10S KA GB2A BP	cs503849	3/4"	3/8"	1/8"	7/16"	3/8"
PL200B10S KD BP	cs503850	3/4"	3/8"	1/8"	7/16"	3/8"
PL300B10S KA 1B005 BP	cs510087	1-3/16"	1/2"	3/16"	5/8"	5/8"
PL300B10S KA GB3A BP	cs510090	1-3/16"	1/2"	3/16"	5/8"	5/8"
PL300B10S KD BP	cs503851	1-3/16"	1/2"	3/16"	5/8"	5/8"
PL400B10S KA 1G032 BP	cs503853	1-9/16"	9/16"	1/4"	7/8"	15/16"
PL400B10S KA GB4A BP	cs510091	1-9/16"	9/16"	1/4"	7/8"	15/16"
PL400B10S KD BP	cs503855	1-9/16"	9/16"	1/4"	7/8"	15/16"



PL200B10S

PL300B10S

PL400B10S

Brass Resettable Padlocks

PL510 Brass Resettable Padlock

- Resettable Combination
- Brass Case with Brass Internal Parts Resists Corrosion
- Hardened Steel Shackle to Resist Cutting
- 10,000 Possible Combinations for Better Security
- Easy-Spin Dial for Quick and Simple Operation
- Attractive blister pack supports retail sales
- Individually packed in shelf packs of 6 with 48 per master carton

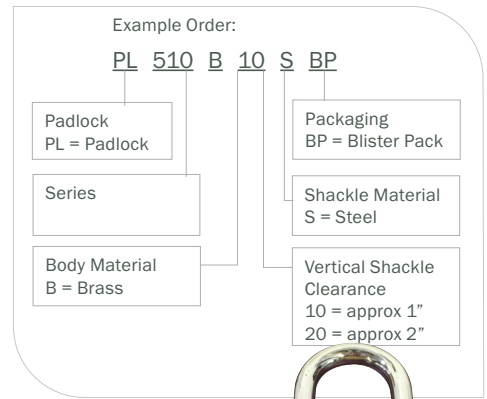

Part#	CLK#	Width	Thickness	Shackle Diameter	Vertical Clearance	Horizontal Clearance
PL510B10S BP	cs509538	2"	7/8"	5/16"	1-1/8"	1"
PL510B20S BP	cs509540	2"	7/8"	5/16"	2-1/4"	1"



PL510B10S

Interchangeable Core Padlocks

- For small format type cores
- Accepts all 6 or 7 pin SFIC-type cores
- Shackle easily changed
- Boxed individually in shelf packs of 6

PL452B/BC Premium Brass SFIC Padlocks

- Solid brass body with chrome plated shackle resists corrosion
- Brushed chrome plated version provides additional finish option and corrosion protection (BC model)
- Hardened steel shackle and double-ball locking to resist cutting and prying
- Key-retaining easily convertible to non-key-retaining

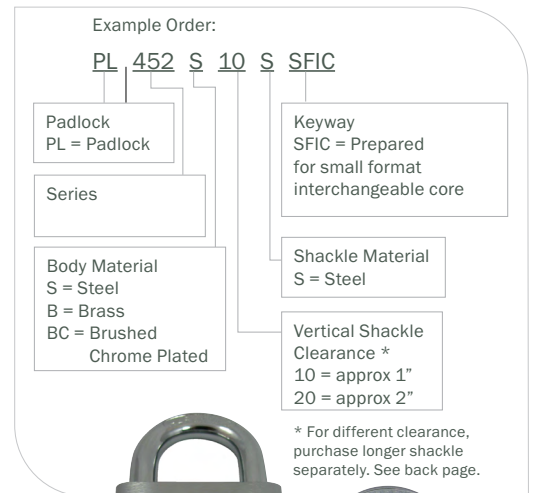

Part#	CLK#	Width	Thickness	Shackle Diameter	Vertical Clearance	Master Carton
PL452B10S SFIC	cs503842	1-3/4"	13/16"	5/16"	1"	<u>72</u>
PL452B20S SFIC	cs503844	1-3/4"	13/16"	5/16"	2"	<u>48</u>
PL452BC10S SFIC	cs503845	1-3/4"	13/16"	5/16"	1"	<u>72</u>
PL452BC20S SFIC	cs503846	1-3/4"	13/16"	5/16"	2"	<u>48</u>



PL452BC10S SFIC



PL452B10S SFIC

PL452S Square Steel SFIC Padlocks

- Solid steel chrome plated body provides corrosion resistance
- Non-key-retaining
- Molybdenum shackle and double-ball locking to resist cutting and prying
- Master cartons of 36

Part#	CLK#	Width	Thickness	Shackle Diameter	Vertical Clearance
PL452S10S SFIC	cs510101	1-3/4"	3/4"	5/16"	1"
PL452S20S SFIC	cs510102	1-3/4"	3/4"	5/16"	2"



PL452S10S SFIC

PL452S10S SFIC

Solid Steel Square Body Padlocks

PL456S Steel Square Body Keyway Padlock

- Solid steel chrome plated body and brass cylinder provide corrosion resistance
- AM3/AM4 keyway, drilled for 6 pins and pinned to 5
- Molybdenum shackle and double-ball locking resist cutting and prying
- Shackle easily changed
- Non-key-retaining
- Boxed or blister packed individually in shelf packs of 6 with 36 per master carton
- Original key blanks available. See page 32.

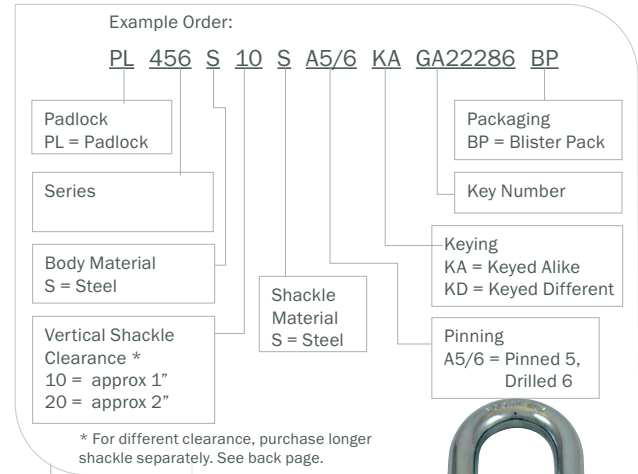

PL456S20S

Part#	CLK#	Width	Thickness	Shackle Diameter	Vertical Clearance
PL456S10S A5/6 KA GA22286	cs510104	1-3/4"	3/4"	5/16"	1"
PL456S10S A5/6 KA GA36253	cs510105	1-3/4"	3/4"	5/16"	1"
PL456S10S A5/6 KD BP	cs510106	1-3/4"	3/4"	5/16"	1"
PL456S10S A5/6 OB	cs510103	1-3/4"	3/4"	5/16"	1"
PL456S20S A5/6 KA GA36253	cs510108	1-3/4"	3/4"	5/16"	2"
PL456S20S A5/6 KA GA53254	cs510109	1-3/4"	3/4"	5/16"	2"

Solid Steel Round Body

PL635S Steel Round Body Keyway Padlock

- Solid steel chrome plated body and brass cylinder provide corrosion resistance
- AM3/AM4 keyway, drilled for 6 pins and pinned to 5
- Molybdenum shackle and double-ball locking resist cutting and prying
- Shackle easily changed
- Non-key-retaining
- Boxed or retail blister packed individually in shelf packs of 6 with 24 per master carton
- Original key blanks available. See page 32.

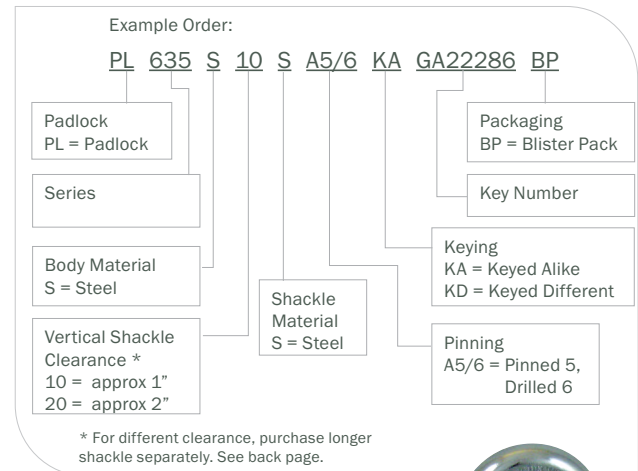

PL635S10S

PL635S20S

Part#	CLK#	Width	Thickness	Shackle Diameter	Vertical Clearance	Horizontal Clearance
PL635S10S A5/6 KA GA22558	cs510116	2-1/2"	1-1/4"	7/16"	1"	15/16"
PL635S10S A5/6 KA GA53282	cs510118	2-1/2"	1-1/4"	7/16"	1"	15/16"
PL635S10S A5/6 KD BP	cs510120	2-1/2"	1-1/4"	7/16"	1"	15/16"
PL635S20S A5/6 KA GA24686	cs510122	2-1/2"	1-1/4"	7/16"	2"	15/16"
PL635S20S A5/6 KA GA53282	cs510127	2-1/2"	1-1/4"	7/16"	2"	15/16"
PL635S20S A5/6 KD BP	cs510141	2-1/2"	1-1/4"	7/16"	2"	15/16"

Discus Padlocks

PL700 Discus Padlocks

- Stainless steel lock body and brass internal parts resist rust and corrosion
- Hardened steel shrouded double-locking shackle to combat cutting, twisting, prying, and wrenching
- Precision 4-pin M1 keyway cylinder for pick resistance
- Key retaining feature to avoid leaving unlocked
- Available keyed alike or keyed differently
- Attractive blister pack supports retail sales (keyed different only)
- Individually packed in shelf packs of 6 with 36 per master carton
- Original key blanks available. See page 32.

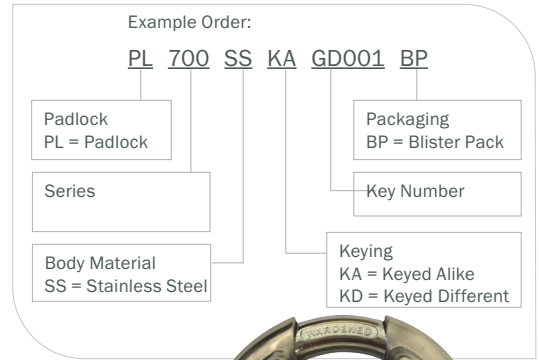

PL700SS

Part#	CLK#	Diameter	Thickness	Shackle Diameter	Vertical Clearance	Horizontal Clearance
PL700SS KA GD001	cs503837	2-3/4"	1-1/8"	3/8"	5/8"	7/8"
PL700SS KA GD002	cs503840	2-3/4"	1-1/8"	3/8"	5/8"	7/8"
PL700SS KD BP	cs503841	2-3/4"	1-1/8"	3/8"	5/8"	7/8"

Hidden Shackle Padlocks Use with PL730 Heavy Duty Hasp or Similar

PL730 Hidden Shackle Padlocks

- Hardened steel lock body for maximum protection against forced entry
- Works with many hasp devices, including General Lock PL730 HASP
- Quality plating on lock and bolt fights rust and corrosion
- Brass 6-pin AM4 keyway cylinder rekeyable into many existing systems
- Boxed or blister packed individually in shelf packs of 4 with 16 per master carton
- Original key blanks available. See page 32.

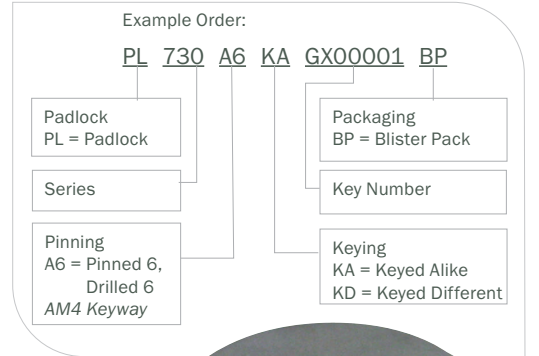

PL730

Part#	CLK#	Diameter	Thickness	Shackle Diameter
PL730 A6 KA GX00001	cs510143	2-7/8"	1-1/2"	3/8"
PL730 A6 KA GX13033	cs510173	2-7/8"	1-1/2"	3/8"
PL730 A6 KD BP	cs510177	2-7/8"	1-1/2"	3/8"

Shrouded Hasp Use with PL730 Steel "Hockey Puck" Round Body Padlocks or Similar Models

PL730 Heavy Duty Hasp

- High security steel material
- Carriage bolts, washers, and nuts included
- Boxed individually in shelf packs of 4, 16 per master carton

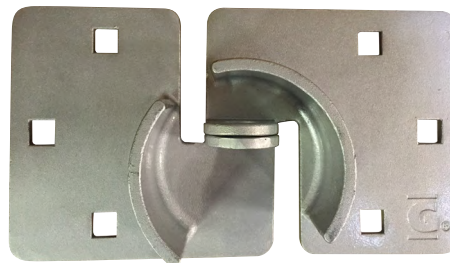

PL730 HASP

Part#	CLK#	Width	Length
PL730 HASP	cs510182	8"	4-3/8"

Laminated Steel Padlocks

PL40L Laminated Steel Padlock

- Laminated steel body and zinc plating for strength and rust resistance
- Hardened shackle resists cutting
- Dual-locking shackle resists prying
- 4-pin tumbler cylinder for pick resistance
- Packed individually in shelf packs of 6 blister packs with 72 per master carton (PL44LP20S master cartons contain 48)
- Original key blanks available. See below.

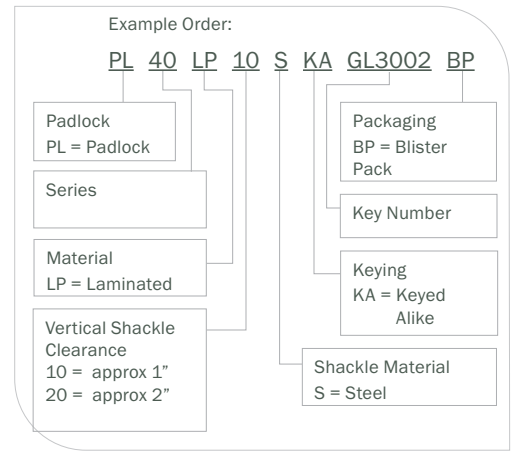
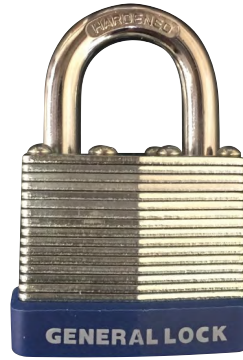

Part#	CLK#	Width	Thickness	Shackle Diameter	Vertical Clearance	Horizontal Clearance
PL40LP10S KA GL3001	cs101058	1-5/8"	7/8"	9/32"	7/8"	3/4"
PL40LP10S KA GL3002	cs101060	1-5/8"	7/8"	9/32"	7/8"	3/4"
PL40LP20S KA GL3002	cs101061	1-5/8"	7/8"	9/32"	2"	3/4"
PL44LP10S KA GL3002	cs101064	1-3/4"	15/16"	5/16"	15/16"	13/16"
PL44LP10S KA GL3001	cs101062	1-3/4"	15/16"	5/16"	15/16"	13/16"
PL44LP20S KA GL3002	cs101065	1-3/4"	15/16"	5/16"	2"	13/16"



Padlock Parts

Part#	CLK#
PL ALLEN WRENCH 2.5MM	cs511034
PL ALLEN WRENCH 1/16"	cs484317
PL CYL A5 PLUG RETAIN CLIP	cs511035
PL CYL A5/6 OB	cs511036
PL CYL A5/6 KA GA42537	cs511037
PL450 CYL ADAPTOR RET SCRW	cs480976
PL450 CYL ADAPTOR	cs480978
PL450 CYLINDER ADAPTOR	cs480979
PL450 CYLINDER TAILPIECE	cs480987
PL450 HARD STL SHACKLE ONLY 2	cs480988
PL450 HARD STL SHACKLE ONLY 3	cs480989
PL450 HARD STL SHACKLE ONLY 4	cs480982
PL450 KEY RETAINING SCREW	cs480983
PL450 KEY RETAINING SPRING	cs480985
PL450 KEY RETAINING SPRING	cs480981
PL450 LIMIT PLATE RET SCRW	cs480991
PL450 SHACKLE BALL BEARING	cs480992
PL450 SHACKLE RETAIN SCRW	cs511039
PL450 SHACKLE SPRING	cs511040
PL452B CAM	cs511041
PL452B CAM	cs511042

Part#	CLK#
PL452B CAM LIMIT PIN	cs511043
PL452B KEY RETURN SPRNG	cs511044
PL452B TLPC 6P	cs511045
PL452B TLPC 7P	cs511046
PL452S CAM & TP	cs511047
PL452S LIMIT PLATE SCREW	cs511050
PL452S/456S MOLY SHACKLE 2	cs511051
PL452S/456S MOLY SHACKLE 3	cs511052
PL452S/456S SHACKLE RET SCRW	cs511053
PL452S/456S SHACKLE SPRING	cs511054
PL452S/456S SHACKLE SPRING	cs511056
PL456S CYL RETAIN COV PLT	cs511057
PL456S CYL RETAIN PLT SCRW	cs511058
PL456S CYL RETAIN SEC NUT	cs511059
PL635 CYL RETAIN COVER PLATE	cs511060
PL635 MOLY SHACKLE ONLY 2	cs511061
PL635 SHACKLE RETAIN SCREW	cs511062
PL635 SHACKLE SPRING	
PL730 CYL A6 KA GX00002	
PL730 CYL RETAIN SCREW	
PL730 PLUG RET SCREW	

Padlock Key Blanks

Part#	CLK#
KB AM3 S BR	cs513975
5-Pin AM3 Keyway, Square Offset Bow, Brass (1046)	
KB AM4 S BR	cs513976
6-Pin AM4 Keyway, Square Offset Bow, Brass (1046A)	
KB200 NP	cs511031
3-Pin K120 Keyway for PL200, Round Bow, Nickel Plated Brass (1092VB)	
KB300/400 NP	cs511032
4-Pin K130 Keyway for PL300 AND PL400, Round Bow, Nickel Plated Brass (1092DS, M13)	
KB4050 NP	cs389618
5-Pin For Old Style Brass Padlock (Discontinued)	
KB4050LAM NP	cs412851
4-Pin For Old Style Laminated Steel Padlock, Thin M1 (Discontinued)	
KB6070 NP	cs389619
6-Pin For Old Style 60MM General Lock Brass Padlock (Discontinued)	
KB700 NP	cs511033
4-Pin K1 Keyway For PL700SS, PL40LP, and PL44LP, Round Bow, Nickel Plated Brass (1092, M1)	



Components

Grade 1 Cylindrical Parts & Components

(to be used with L100 and LX100 series)

Part#	Description / Dimensions / Finish	CLK#
1DL 626 234 S	Dead latch, 2-3/4" Square Corner / US26D	cs342522
1DL 605 234 S	Dead latch, 2-3/4" Square Corner / US3	cs342518
1DL 605 238 S	Dead latch, 2-3/8" Square Corner / US3	cs342517
1DL 613 234 S	Dead latch, 2-3/4" Square Corner / US10B	cs342520
1DL 613 238 S	Dead latch, 2-3/8" Square Corner / US10B	cs342519
1DL 626 238 S	Dead latch, 2-3/8" Square Corner / US26D	cs342521
1DL EXT LINK FOR 3-3/4"	3-3/4" Ext. link for 2-3/8" Backset	cs498905
1DL EXT LINK FOR 5"	5" Ext. link for 2-3/4" Backset	cs436459
1SL 605 234 S	Spring Latch, 2-3/4" Square Corner / US3	cs342524
1SL 605 238 S	Spring Latch, 2-3/8" Square Corner / US3	cs342523
1SL 613 234 S	Spring Latch, 2-3/4" Square Corner / US10B	cs342526
1SL 613 238 S	Spring Latch, 2-3/8" Square Corner / US10B	cs342525
1SL 626 234 S	Spring Latch, 2-3/4" Square Corner / US26D	cs342528
1SL 626 238 S	Spring Latch, 2-3/8" Square Corner / US26D	cs342527
L1 INSERT	Black Insert for Grade 1 Lever	cs101551
L1 IC-TP	For Grade 1 IC Lever	cs104397
L1 SP 605	Grade 1 Lever 605 Screwpack / US3	cs498918
L1 SP 613	Grade 1 Lever 613 Screwpack / US10B	cs498917
L1 SP 626	Grade 1 Lever 626 Screwpack / US26D	cs498916
L1 TP	For Grade 1 C Lever	cs103100
L195 TP	For L195R-360 C Lever	cs103102
L1L2 TB	Thru-Bolts for Grade 1 and Grade 2 Lever	cs502181
LK12 CYL CAP	Cylinder Cap for Grade 1 and Grade 2	cs106654
TS 605	T-strike SQ. corner for G1 & G2 lever / US3	cs342529
TS 613	T-strike SQ. corner for G1 & G2 lever / US10B	cs342530
TS 626	T-strike SQ. corner for G1 & G2 lever / US26D	cs342531

Finishes:



626
U.S. = US26D
Satin Chrome



613
U.S. = US10B
Dark Bronze, Oil Rubbed



605
U.S. = US3
Bright Brass



L1 TP



L1 IC-TP



TS 626

Components

Grade 2 Cylindrical Parts & Components

(to be used with L200, LX200 and K200 series)

Part#	Description / Dimensions / Finish	CLK#
2DL 626 234 R	Dead latch, 2-3/4" Radius Corner / US26D	cs288314
2DL 234 D	Dead latch, 2-3/4" Drive-In	cs288310
2DL 238 D	Dead latch, 2-3/8" Drive-In	cs288309
2DL 605 234 R	Dead latch, 2-3/4" Radius Corner / US3	cs288313
2DL 605 234 S	Dead latch, 2-3/4" Square Corner / US3	cs288321
2DL 605 238 R	Dead latch, 2-3/8" Radius Corner / US3	cs288312
2DL 605 238 S	Dead latch, 2-3/8" Square Corner / US3	cs288316
2DL 613 234 S	Dead latch, 2-3/4" Square Corner / US10B	cs288322
2DL 613 238 R	Dead latch, 2-3/8" Radius Corner / US10B	cs322885
2DL 613 238 S	Dead latch, 2-3/8" Square Corner / US10B	cs288317
2DL 626 234 S	Dead latch, 2-3/4" Square Corner / US26D	cs288323
2DL 626 238 R	Dead latch, 2-3/8" Radius Corner / US26D	cs322886
2DL 626 238 S	Dead latch, 2-3/8" Square Corner / US26D	cs288318
2DL EXT link for 3-3/4"	3-3/4" Ext. link for 2-3/8" Backset	cs360919
2DL EXT link for 5"	5" Ext. link for 2-3/8" Backset	cs413156
2SL 234 D	Spring Latch, 2-3/4" Drive-In	cs322888
2SL 238 D	Spring Latch, 2-3/8" Drive-In	cs322887
2SL 605 234 S	Spring Latch, 2-3/4" Square Corner / US3	cs324180
2SL 605 238 R	Spring Latch, 2-3/8" Radius Corner / US3	cs322889
2SL 605 238 S	Spring Latch, 2-3/8" Square Corner / US3	cs322890
2SL 613 234 R	Spring Latch, 2-3/4" Radius Corner / US10B	cs322896
2SL 613 234 S	Spring Latch, 2-3/4" Square Corner / US10B	cs324181
2SL 613 238 R	Spring Latch, 2-3/8" Radius Corner / US10B	cs322894
2SL 613 238 S	Spring Latch, 2-3/8" Square Corner / US10B	cs322895
2SL 626 234 R	Spring Latch, 2-3/4" Radius Corner / US26D	cs322900
2SL 626 234 S	Spring Latch, 2-3/4" Square Corner / US26D	cs324182
2SL 626 238 R	Spring Latch, 2-3/8" Radius Corner / US26D	cs322897
2SL 626 238 S	Spring Latch, 2-3/8" Square Corner / US26D	cs322899
K2 IC TP	Tail Piece for Grade 2 SFIC Knob	cs498925
K2 SP 605	Grade 2 Knob 605 Screwpack / US3	cs498924
K2 SP 613	Grade 2 Knob 613 Screwpack / US10B	cs498923
K2 SP 630	Grade 2 Knob 630 Screwpack / US32D	cs498922
L2 INSERT	Black Insert for Grade 2 Lever	cs101552
L2 IC TP 2	IC Tail piece for Grade 2 IC prep lever	cs463244
L2 SP 605	Grade 2 Lever 605 Screwpack / US3	cs498921
L2 SP 613	Grade 2 Lever 613 Screwpack / US10B	cs498920
L2 SP 626	Grade 2 Lever 626 Screwpack / US26D	cs498919
L2K2 TP	For Grade 2 Cylindrical Levers and Knobs	cs103088
LK12 CYL CAP	Cylinder Cap for Grade 1 and Grade 2	cs106654
TS 605	T-strike SQ. corner for G1 & G2 lever / US3	cs342529
TS 613	T-strike SQ. corner for G1 & G2 lever / US10B	cs342530
TS 626	T-strike SQ. corner for G1 & G2 lever / US26D	cs342531

Finishes:

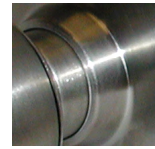

630
U.S. = US32D
Satin Stainless Steel



626
U.S. = US26D
Satin Chrome



613
U.S. = US10B
Dark Bronze, Oil Rubbed

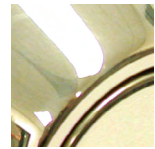

605
U.S. = US3
Bright Brass



L2 IC TP 2



L2K2 TP



K2 IC TP

Components

Grade 3 Cylindrical Components

(to be used with K300 series)

Part#	Description / Dimensions / Finish	CLK#
3DL 630 ADJ R	Dead latch, Adjustable Radius Corner / US32D	cs288328
3DL 605 ADJ R	Dead latch, Adjustable Radius Corner / US3	cs288326
3DL 605 ADJ S	Dead latch, Adjustable Square Corner / US3	cs288329
3DL 609 ADJ R	Dead latch, Adjustable Radius Corner / US5	cs288327
3DL 630 ADJ S	Dead latch, Adjustable Square Corner / US32D	cs288332
3SL 234 D	Spring latch, 2-3/4" Drive-In	cs323151
3SL 238 D	Spring latch, 2-3/8" Drive-In	cs323150
3SL 605 ADJ R	Spring latch, Adjustable Radius Corner / US3	cs323152
3SL 605 ADJ S	Spring latch, Adjustable Square Corner / US3	cs324183
3SL 609 ADJ R	Spring latch, Adjustable Radius Corner / US5	cs323153
3SL 609 ADJ S	Spring latch, Adjustable Square Corner / US5	cs324184
3SL 630 ADJ R	Spring latch, Adjustable Radius Corner / US32D	cs323155
3SL 630 ADJ S	Spring latch, Adjustable Square Corner / US32D	cs324185

Finishes:

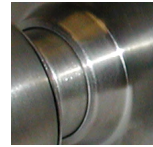

630
U.S. = US32D
Satin Stainless Steel



626
U.S. = US26D
Satin Chrome

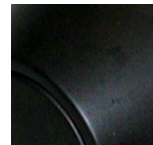

613
U.S. = US10B
Dark Bronze, Oil Rubbed



609
U.S. = US5
Antique Brass



605
U.S. = US3
Bright Brass

Deadlock Parts & Components

Part#	Description / Dimensions / Finish	CLK#
1DB DC SP 605	Grade 1, Double Cylinder Deadbolt / Screwpack, 605 / US3	cs102093
1DB DC SP 626	Grade 1, Double Cylinder Deadbolt / Screwpack, 626 / US26D / US26D	cs102166
1DB SC SP 626	Grade 1, Single Cylinder Deadbolt / Screwpack, 626 / US26D	cs102167
2DB DC SP 605	Grade 2 Double Cylinder Deadbolt / Screwpack, 605 / US3	cs102158
2DB DC SP 613	Grade 2 Double Cylinder Deadbolt / Screwpack, 613 / US10B	cs102161
2DB DC SP 626	Grade 2 Double Cylinder Deadbolt / Screwpack, 626 / US26D	cs102164
2DB SC SP 605	Grade 2 Single Cylinder Deadbolt / Screwpack, 605 / US3	cs101533
2DB SC SP 613	Grade 2 Single Cylinder Deadbolt / Screwpack, 613 / US10B	cs101534
2DB SC SP 626	Grade 2 Single Cylinder Deadbolt / Screwpack, 626 / US26D	cs101535
D162-1WS 626	One-Way Security Screw for D162 / 2/PK, 626 / US26D	cs105928
D162-1WS 626	One-Way Security Screw for D162 / 2/PK, 626 / US26D	cs101940
D1D2 DC C TP - EX	Tailpiece for D662 SCHL C & D162 SCHL C, Double Cylinder, Outside	cs498913
D1D2 DC C TP - IN	Tailpiece for D662 SCHL C & D162 SCHL C, Double Cylinder, Outside	cs498912
D1D2 DC IC TP	Tailpiece for D662 SFIC & D162 SFIC, Double Cyl	cs498915
D1D2 DC TDK 214 605	Thick Door Kit to 2-1/4" for D662 and D162 Double Cylinder / US3	cs468938
D1D2 DC TDK 214 613	Thick Door Kit to 2-1/4" for D662 and D162 / US10B	cs483539
D1D2 DC TDK 214 626	Thick Door Kit to 2-1/4" for D662 and D162 Double Cylinders / US26D	cs468941
D1D2 SC C TP	Tailpiece for D660 SCHL C & D160 SCHL C, Single Cylinder	cs498906
D1D2 SC IC TDK 214 605	Thick Door Kit to 2-1/4" for D660 SFIC and D160 / US3, SFIC, Single Cylinder	cs502184
D1D2 SC IC TDK 214 613	Thick Door Kit to 2-1/4" for D660 SFIC and D160 / US10B, SFIC, Single Cylinder	cs502183
D1D2 SC IC TDK 214 626	Thick Door Kit to 2-1/4" for D660 SFIC and / US26D, D160 SFIC, Single Cylinder	cs502182
D1D2 SC TDK 214 605	Thick Door Kit to 2-1/4" for D660 and D160 Single Cylinder / US3	cs468939
D1D2 SC TDK 214 613	Thick Door Kit to 2-1/4" for D660 and D160 Single Cylinder / US10B	cs483537
D1D2 SC TDK 214 626	Thick Door Kit to 2-1/4" for D660 and D160 Single Cylinders / US26D	cs468943
D1D2 SC IC TP	Tailpiece for D660 SFIC & D160 SFIC, Single Cyl	cs498914

Components

Deadlock Parts & Components

Part#	Description / Dimensions / Finish	CLK#
D1-SR-605	Adapter Ring for Grade 1 Deadlocks / 2 Per Lock Required / US3	cs101940
D1-SR-613	Adapter Ring for Grade 1 Deadlocks / 2 Per Lock Required / US10B	cs102940
D1-SR-626	Adapter Ring for Grade 1 Deadlocks / 2 Per Lock Required / US26D	cs102053
D2-SR-605	Adapter Ring for Grade 2 Deadlocks / 2 Per Lock Required / US3	cs102931
D2-SR-613	Adapter Ring for Grade 2 Deadlocks / 2 Per Lock Required / US10B	cs102933
D2-SR-626	Adapter Ring for Grade 2 Deadlocks / 2 Per Lock Required / US26D	cs102932
D3-DC-TP	Tailpiece for D362 Double Cylinder	cs480572
D3-SC-TP	Tailpiece for D360 Single Cylinder	cs480573
DB-234 626	Bolt, 2-3/4" for D660s / US26D	cs263357
DB-234 605	Bolt, 2-3/4" for D660s / US3	cs263356
DB-234 613	Bolt, 2-3/4" for D660s / US10B	cs263358
DB-238 605	Bolt, 2-3/8" for D660s / US3	cs259372
DB-238 613	Bolt, 2-3/8" for D660s / US10B	cs259373
DB-238 626	Bolt, 2-3/8" for D660s / US26D	cs259375
DB-6WL-605	Bolt, 6-WAY Adjustable for D160s / US3	cs447836
DB-6WL-613	Bolt, 6-WAY Adjustable for D160s / US10B	cs447837
DB-6WL-626	Bolt, 6-WAY Adjustable for D160s / US26D	cs447838
DBA-605	Bolt, Adjustable, Only Sq. Faceplate, for D160s / US3	cs429309
DBA-613	Bolt, Adjustable, Only Sq. Faceplate, for D160s / US10B	cs429310
DBA-626	Bolt, Adjustable, Only Sq. Faceplate, for D160s / US26D	cs429311
DLGL 234 605 S	Gate Latch Mechanism Only, 2-3/4" SQ. CORNERS / US3	cs449678
DLGL 234 626 S	Gate Latch Mechanism Only, 2-3/4" SQ. CORNERS / US26D	cs449680
DLGL 238 605 S	Gate Latch Mechanism Only, 2-3/8" SQ. CORNERS / US3	cs449223
DLGL 238 626 S	Gate Latch Mechanism Only, 2-3/8" SQ. CORNERS / US26D	cs449225

Finishes:



626
U.S. = US26D
Satin Chrome



613
U.S. = US10B
Dark Bronze, Oil Rubbed



605
U.S. = US3
Bright Brass

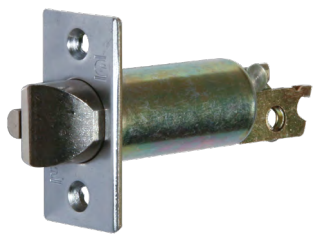

DLGL 234 626 S

Components

Door Closer Components

Part#	Description / Dimensions / Finish	CLK#
36/3700-A-1	RE Type End Loading 1" C3600 & C3700	cs502238
36/3700-JOXAL-9/16	TD Type Offset Arm, ALUM, 9/16 C3600 & C3700	cs502241
36/3700-JOXDU-9/16	TD Type Offset Arm, DURO, 9/16 C3600 & C3700	cs502242
36/3700-K-5/8	RE Type End Loading 5/8" C3600 & C3700	cs502239
36/3700-PT-7/8	RE Type End Loading 7/8" C3600 & C3700	cs502240
36/3700-S	S Type Side Loading Arm for C3600 & C3700	cs502236
36/3700-VOXAL-7/8	TD Type Offset Arm, ALUM, 7/8 C3600 & C3700	cs502246
36/3700-VOXDU-7/8	TD Type Offset Arm, DURO, 7/8 C3600 & C3700	cs502249
5000-DP 689	Drop Plate for C5000 / ALUM	cs275048
5000-DP 695	Drop Plate for C5000 / DURO	cs275049
5000-H 689	Friction Hold Open Arm for C5000 / ALUM	cs275057
5016-H ARM 689	Friction Hold Open Arm for C5016H / ALUM	cs104750
5016-H ARM 695	Friction Hold Open Arm for C5016H / DURO	cs104753
5500-C 689	Cover for C5000 / ALUM	cs275044
5500-C 695	Cover for C5000 / DURO	cs275047
7000-DP 689	Drop Plate for C7000 / ALUM	cs275055
7000-DP 695	Drop Plate for C7000 / DURO	cs275056
7000-H 689	Friction Hold Open Arm for C7000 / ALUM	cs275064
7300-C 689	Cover for C7000 / ALUM	cs101540
7500-C 689	Cover for C7000 / ALUM	cs101543
7500-C 695	Cover for C7000 / DURO	cs101553
9016 ARM 689	Standard Arm for C9016 / ALUM	cs104754
9016 ARM 695	Standard Arm for C9016 / DURO	cs104755
9016-C 689	Cover for C9016 / ALUM	cs101544
9016-C 695	Cover for C9016 / DURO	cs101545
9016-DP 689	Drop Plate for C9016 / ALUM	cs336787
9016-DP 695	Drop Plate for C9016 / DURO	cs336788
9016-DP PA 689	Parallel Arm Drop Plate for C9016 / ALUM	cs349899
9016-DP PA 695	Parallel Arm Drop Plate for C9016 / DURO	cs349900
9016-H 689	Friction Hold Open Arm for C9016 / ALUM	cs336789
9016-H 695	Friction H/O ARM F/9000 SERIES	cs336791
9016-MH 689	Mechanical Hold Open Arm w/ stop for C9000 / ALUM	cs357240
9016-MH 695	Mechanical Hold Open Arm w/ stop for C9000 / DURO	cs357241
9016-S 689	Non Hold Open Arm w/ stop for C9000 / ALUM	cs357238
9016-S 695	Non Hold Open Arm w/ stop for C9000 / DURO	cs357239
C3005H-689	Surface Mounted, Size 5, Tri-MNT, Hold Open / ALUM	cs104267

Features (Drop plates/Arms/Covers):

- Case Qty: 10

C3600 & 3700 Series



36/3700-S



36/3700-JOXAL-9/16

C5000 Series



Drop plate for the 5000 Series closer.
5000-DP shown



Friction hold-open arm for the 5000 Series closer.
5000-H shown



Full cover for the 5000 Series closer.
5500-C shown

C7000 Series



Drop plate for the 7000 Series closer.
7000-DP shown



Friction hold-open arm for the 7000 Series closer.
7000-H shown

C9000 Series



Drop plate for the 9000 Series closer.
9016-DP shown



Parallel arm drop plate for 9000 Series closer.
9016-DP PA shown



Friction hold-open arm for the 9000 Series closer.
9016-H shown



Mechanical hold - open arm with turn and stop for the 9000 Series closer.
9016-MH shown

Components

ED2300 Series Components

Part#	Description / Dimensions / Finish	CLK#
ED S 237 630	Rim Strike for Double Doors for ED2300R / US32D	cs395553
ED23-Bottom Strike	Bottom Strike for ED2300V	cs446238
ED23-DOGGING KEY		cs102465
ED23-DOGGING MECH		cs102955
ED23-ECS 689	End Cap SET / ALUM	cs444019
ED23-ECS 695	End Cap SET / DURO	cs444020
ED23-LBA 689	Bottom Latch Assembly for ED2300V / ALUM	cs444021
ED23-LBA 695	Bottom Latch Assembly for ED2300V / DURO	cs444025
ED23-LTA 689	Top Latch Assembly for ED2300V / ALUM	cs444026
ED23-LTA 695	Top Latch Assembly for ED2300V / DURO	cs444027
ED23-RBA 689	Bottom Rod Assembly for ED2300V / ALUM	cs444028
ED23-RBA 695	Bottom Rod Assembly for ED2300V / DURO	cs444029
ED23-RTA78 689	Top Rod Assembly 7'-8' for ED2300V / ALUM	cs444030
ED23-RTA78 695	Top Rod Assembly 7'-8' for ED2300V / DURO	cs444031
ED23-SNB 689	Sex Nuts & Bolts (SNB) / ALUM	cs444032
ED23-SNB 695	Sex Nuts & Bolts (SNB) / DURO	cs444033
ED23-Top Strike	Top Strike for ED2300V	cs446241
ED232-RP	Roller Strike w/shim for ED2300R-P	cs444016
ED233-RF	Roller Strike w/shim for ED2300R-F	cs444017
ED23ER-12 689	12" Extension Rod for ED2300V / ALUM	cs415269
ED23ER-12 695	12" Extension Rod for ED2300V / DURO	cs448072

ED1000 Series Components

Part#	Description / Dimensions / Finish	CLK#
ED10CES 313	Mortise Cylinder Pad/Escutcheon for ED1048 / DURO	cs452143
ED10CES 628	Mortise Cylinder Pad/Escutcheon for ED1048 / ALUM	cs452145
ED10CVER-12	12" Extension Rod for ED1048CV	cs439328
ED10CVER-24	24" Extension Rod for ED1048CV	cs439329

Finishes:



689
-
Aluminum

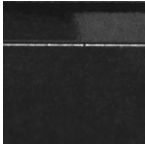

695
-
Dark Bronze



630
U.S. = US32D
Satin Stainless Steel

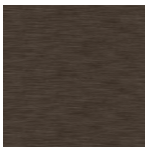

313
-
Duranodic

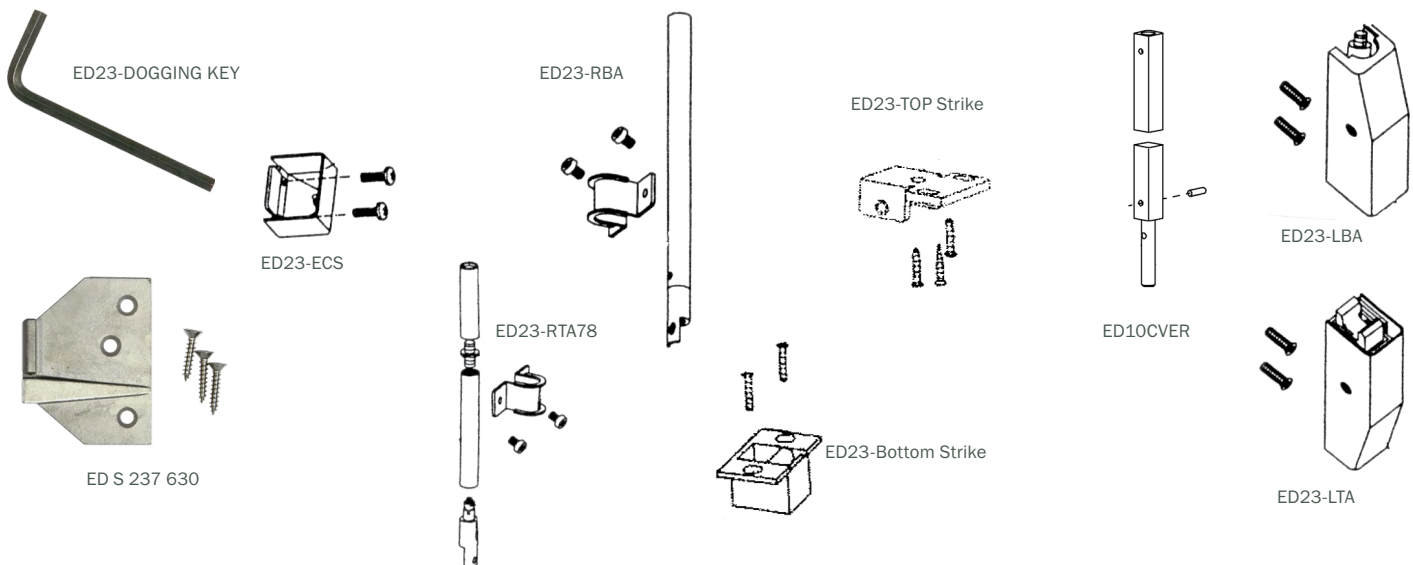

For more info or installation instructions visit: generallock.com, or order from: clarksecurity.com.

Finish Code Numbers:

605	US3	Bright Brass
606	US4	Satin Brass
609	US5	Antique Brass
613	US10B	Dark Bronze, Oil Rubbed
619	US15	Satin Nickel
626	US26D	Satin Chrome
628	US28	Aluminum
630	US32D	Satin Stainless Steel
689	-	Aluminum
695	-	Dark Bronze
697	US3	Bright Brass Plated
700	US26	Bright Chrome Plated

ALUM = Aluminum
DURO = Duranodic

BP = Brass Plated
PC = Prime Coat
SL = Silver

313 = Duranodic

Certifications:

Many products sold by General Lock are independently tested and comply with ANSI and UL standards. Field modification or disassembly beyond normal installation will void certification. Please see UL and ANSI web sites for details on certifications mentioned in this catalog.

ANSI

Underwriters Laboratories, Inc.

Federal Specifications

ADA

California Fire Marshal Code



Copyright: ©2014 General Lock, a division of Anixter Inc. All text, graphics, photographs, and any selection, coordination, and arrangement of such materials contained herein is copyrighted and owned by General Lock. No material from this catalog may be copied, reproduced, republished, uploaded, posted, transmitted, or distributed in any way unless permission has been expressly granted by General Lock and any reproduction of this catalog, in whole or in part, and/or any information or materials contained in it is prohibited without the express authorization of General Lock. General Lock is a trademark or registered trademark of General Lock. ANY MATERIALS OR INFORMATION PROVIDED BY GENERAL LOCK IN THIS CATALOG IS PROVIDED "AS IS" WITHOUT WARRANTY OF ANY KIND. GENERAL LOCK ASSUMES NO RESPONSIBILITY FOR ERRORS OR OMISSIONS IN THIS CATALOG, OR OTHER PUBLICATION OR OTHER DOCUMENTS, WHICH ARE REFERENCED BY THIS PUBLICATION.

All other brand names or product names, including Arrow, Best, Corbin-Russwin, Falcon, Kwikset, KSP, Sargent, Schlage, Weiser, and Yale, referenced herein are trademarks, registered trademarks, service marks, or trade names of the respective manufacturers of such products and are owned by their respective holders. General Lock reserves the right to make changes in designs and specifications, to make addition or improvements on its products or to discontinue products without incurring any obligation. General Lock is not responsible for modification, addition or alteration to our products by others. Products may not appear as depicted. General Lock warrants only to Buyer that the products will be free from defects in material and workmanship for a period of 12 months from the date of shipment of the products unless a longer period is specified. This warranty does not cover wear and tear and shall be ineffective and shall not apply to products that have been subjected to misuse or abuse, neglect, accident, damage, or improper installation, or maintenance. Buyer's sole and exclusive remedy under these warranties will be limited to, at General Lock's sole option and expense, refund of the purchase price of, or the repair or replacement for of, the products or parts thereof which General Lock reasonably determines do not conform with these warranties. Buyer will inspect the products upon delivery and will promptly notify General Lock in writing of any defect in the products. Proof of purchase is required. **DISCLAIMER OF WARRANTIES: THE FOREGOING WARRANTIES ARE EXCLUSIVE AND IN LIEU OF, AND GENERAL LOCK DISCLAIMS, AND BUYER WAIVES, ALL OTHER WARRANTIES OF MERCHANTABILITY, FITNESS FOR A PARTICULAR PURPOSE AND OF ANY OTHER TYPE, WHETHER EXPRESS OR IMPLIED, ARISING BY LAW (STATUTORY OR OTHERWISE) AND WHETHER OR NOT OCCASIONED BY GENERAL LOCK'S NEGLIGENCE. LIMITATION OF LIABILITY: IN NO EVENT SHALL GENERAL LOCK BE LIABLE FOR LOST PROFITS OR ANY SPECIAL, INCIDENTAL, INDIRECT, PUNITIVE, OR CONSEQUENTIAL DAMAGES, INCLUDING ANY DAMAGES OCCASIONED BY GENERAL LOCK'S NEGLIGENCE. IN ADDITION, GENERAL LOCK'S LIABILITY ON ANY CLAIMS FOR DAMAGES OR CLAIMS ARISING OUT OF OR CONNECTED WITH THIS AGREEMENT OR THE SALE, DELIVERY OR USE OF THE PRODUCTS SHALL NOT EXCEED THE PURCHASE PRICE OF THE PRODUCTS AND/OR SERVICES DELIVERED. IN THE EVENT THIS DISCLAIMER OF WARRANTY STATEMENT IS DISALLOWED BY APPLICABLE LAW, SUCH EXPRESS OR IMPLIED WARRANTIES SHALL BE LIMITED IN DURATION TO THE WARRANTY PERIOD (OR THE MINIMUM PERIOD REQUIRED BY THE APPLICABLE LAW).**

Functions:

ANSI Code



10 - PASSAGE SET

Latch bolt operated by knob/lever, from either side at all times.



F75



40 - PRIVACY LOCK

Latch bolt operated by knob/lever from either side. Outside knob/lever is locked by push button or other locking device inside and unlocked by emergency release outside, operating inside knob/lever or closing door.



F76



53 - ENTRANCE LOCK

Dead locking latch bolt operated by knob/lever from either side except when outside knob/lever is locked by the push or turn button inside. Key outside or operating inside knob/lever releases push or turn button unlocking outside knob/lever except when push or turn button has been rotated to keep outside knob/lever locked. Inside push or turn button must be manually operated to unlock outside knob/lever. Inside knob/lever always operates latch bolt.



F109



70 - CLASSROOM LOCK

Dead locking latch bolt operated by knob/lever from either side except when outside knob/lever is locked from outside by key. Inside knob/lever always operative.



F84



80 - STOREROOM LOCK

Dead locking latch bolt operated by key in outside knob/lever, or by operating inside knob/lever. Outside knob/lever is always inoperative.



F86

82 - Asylum / Institutional Lock F87

Dead locking latch bolt operated by key in levers, from either side. Both levers always inoperative.



95 - Classroom Security LOCK F110

Dead locking latch bolt operated by lever from either side. Key either inside or outside locks or unlocks outside lever. Inside lever always operates latch bolt.



Electrically Unlocked(Fail Secure)

Dead locking latch bolt operated by outside lever when outside lever is unlocked by electric current, by key in outside lever, or by operating inside lever





CLARK
An Anixter Company

To order contact your local CLARK sales representative at 1-844-52-CLARK.

Corporate Office
CLARK Security Products
4775 Viewridge Ave.
San Diego CA 92123-1641
Toll-free: 1 (800) 854-2088

About CLARK: <http://clarksecurity.com/about-us>
Legal Statement: <http://anixter.com/legalstatement>
GL_Catalog_2015-2016 © 2016 Anixter Inc. • 06/16

1-844-522-5275 | clarksecurity.com

Products. Technology. Services. Delivered Globally.